

FALCON 500G2

AUTOMATIC HARDNESS TESTER

VICKERS, MICRO VICKERS, KNOOP & BRINELL



FALCON 500G2

Unparalleled configuration freedom...

The FALCON 500G2 offers a leading technology base for manual, automatic or fully automated testing of Micro and Macro Vickers, Knoop or Brinell assignments.

With a wide choices of test force configurations, answering any possible imagination, the FALCON 500G2 can be completed with fully integrated hardware options to assure a match with the particular testing tasks of your industry. Coming from a leading edge of mechanical design, the load cell, closed loop system of the base unit can be completed with manual or digital micrometers or for more testing comfort, with motorized CNC stages.

The unique motorized ball bearing Z-axis provides accurate height movement and high speed autofocus. The user interface, provides manual & automatic measurement and a wide selection of standard and optional testing applications, supporting a high resolution (HD) camera and a second (optional) full work stage overview camera.



HARDNESS SCALES

	VICKERS	0.1gf - 60kgf
	KNOOP	1gf - 5kgf
	BRINELL	1kgf - 62.5kgf



Select your required test force range...

0.1gf	5gf	2kgf		FALCON 500G2 - OPTION 1*	62.5kgf
0.1gf	10gf	2kgf		FALCON 500G2 - OPTION 2	62.5kgf
0.1gf	10gf	10kgf		FALCON 500G2 - OPTION 3	62.5kgf
0.1gf	10gf		31.25kgf	FALCON 500G2 - OPTION 4	62.5kgf
0.1gf	10gf			FALCON 500G2 - OPTION 5	62.5kgf
0.1gf		200gf		FALCON 500G2 - OPTION 6	62.5kgf

Upgrade now, later, at any moment, during order or online!

EXTENSION A	0.1gf - 1gf	EXTENSION B	1gf - 10gf	EXTENSION C	10gf - 200gf
EXTENSION D	2kgf - 10kgf	EXTENSION E	10kgf-31.25kgf	EXTENSION F	31.25kgf - 62.5kgf

* Fixed force range, can not upgrade.

HIGHLIGHTS

- 1 Multi Load Cell, Closed Loop force application system, error <0,25%
- 2 6 position turret, 2 indenter positions (optional), 4 LWD objective positions of which 2 installed
- 3 Turret collision detection and workpiece retraction safety system
- 4 11 Megapixel, Full HD+, integrated TTL camera system
- 5 HD full color stage overview camera with optical zoom system
- 6 White TTL power LED, Dual bank power LED stage illumination
- 7 Z-axis with ball bearing spindle (standard)
- 8 Integrated system controller, i7 processor, mSSD Raid system storage
- 9 Industrial 27" touchscreen, option for 27" or 2 x 24" screens or projector
- 10 Top-class replaceable body parts, shock proof ABS covers

BOUNDLESS INNOVATION



Observe, Think, Try, Change...

Rigidity and perpendicular indenter positioning are crucial to obtain Vickers indents with a perfect geometry. Re-invented, adjustable indenter actuators provide maintenance free, smooth force application, easy to access and easy to replace indenters. Optional XY-stage overview camera reduces application set up time dramatically.

Changing the game...

1 6 POSITION PRECISION TURRET & OPTICAL SYSTEM

The 6 position turret is supplied as a standard feature on all 500G2 models and allows to install indenters for Vickers, Knoop and Brinell (balls 1mm 2.5mm & 5mm) testing. The FALCON 500G2 has four objective positions. Depending on the configuration, choose from 2.5X, 5X, 10X, 20X, 50X, 100X that, in combination with the HD camera, with digital zoom, provide crisp images.

2 STAGE OVERVIEW CAMERA (OPTIONAL)

Create magnified sample overview with the standard on-board, autofocus, optical & digital zoom overview camera. The field of view of this sophisticated full color camera system does not limit you to one field of view, but gives a ZOOM range from 40 x 30 up to 150 x 110mm without the need to use time consuming scan and stitch functions.

Once the viewing area needs to be larger than the zoom range, scanning and stitching can be selected to create full stage overview. Click and go is one of the standard testing features of the overview camera. Just click randomly on designated area's and push "start". All tests run automatically. The pattern video overlay function eases positioning of multiple test rows or patterns across the specimen. The pattern video overlay scales automatically with every magnification, stepless, while the zoom camera decreases or enlarges the overview.

3 DYNAMIC Z-AXIS CONTROL & COLLISION DETECTION

A high end ball bearing Z-axis spindle is one of the very unique functions. Z-axis displacement at an accuracy of micron's supports ultra-fast auto focus. Z-axis controls are nearly limitless; CNC as a result from a test program, by touchscreen indicators, by the scroll wheel of the mouse, by fast up and down buttons or from a scroll wheel on the front of the machine. Speed control related to your own movement; (0.01 up to 20 mm/s). To avoid any collision between the workpiece and the turret, the Z-axis is controlled by a flawless collision detection and Z-axis retraction system. So neither the tester nor the workpiece are exposed to any damage.

4 HIGH SPEED CNC MOTORIZED XY-STAGE (OPTIONAL)

Save time and improve efficiency with one of the high speed, highly accurate motorized XY-stages. Available in variable sizes from standard, to large and extra-large. Enable automated sequencing of multiple samples. The ultra-high accuracy and repeatability guarantee precise positioning of indents and allow re-evaluation of any measurement points in batch or single view. Repeatability within 3 micron.



5 27" HD TOUCHSCREEN OPERATOR INTERFACE

All machine control and process workflow can easily be operated from the 27" industrial capacitive touchscreen. At choice a 27" or 2x24" screen(s) can be connected.

6 SHOCK RESISTANT ABS MACHINE COVERS

The tester is fitted with a high-end external shell structure. The shock proof and damage resistant ABS machine covers can withstand the harshest environment.

AUTOMATIC IMAGE EVALUATION

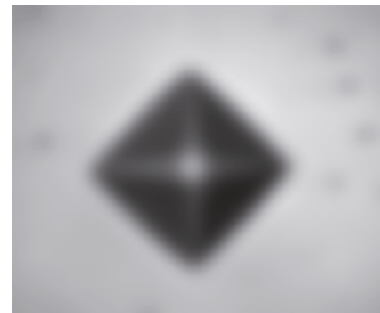

1

1 AUTO FOCUS

Fast & precise, observe how IMPRESSIONS™ finds focus from a large distance, as far as the travel of the Z-axis allows. Algorithms used for close distance autofocusing set new standards in AF speed.



2 AUTOMATIC MEASUREMENT

Manual positioning of filar lines is no longer required. IMPRESSIONS™ refined measurement algorithms detect indents even on very poor or scratched surfaces and measure the relevant indent dimensions according to standards. Stay in control by switching to manual measure mode and have the option of adjusting measurements by touching the screen or using the mouse. Filar lines can be colored to give the best contrast against the specimen's surface. To assure that measurements meet relevant standards on symmetry, enable the automatic indent check. All hardness values can be converted to other scales according to ISO 18265, ISO 50150, ASTM E140.

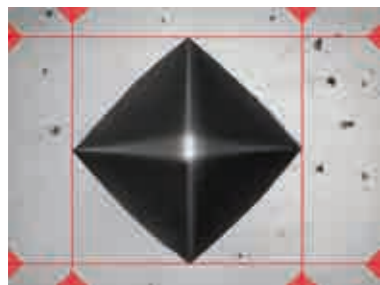

2

3 ILLUMINATION SETTINGS

IMPRESSIONS™ software automatic illumination system adapts to the correct illumination regardless of the sample surface quality, wherever on the sample, independent from material (steel, carbide, coated or ceramic). Contrast, Brightness and program, can be set automatically for each measurement or controlled manually. Sharpness can be stored with the pre-determined test.

Too bright

OK

Too dark

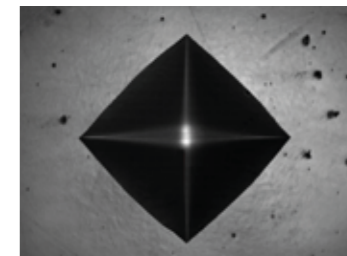
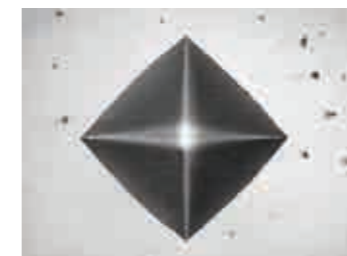

3



4

Irregular surface

Regular surface

Poor surface

4 REFINED IMAGE DETECTION

Complex, refined algorithms ensure reproducible measurements on different materials and even on scratched and damaged surfaces.

Evaluate whatever you want, --
because what gets measured, gets produced...

The purpose of software is to control complexity...

Software that optimizes user comfort with a wide range of standard functionality such as auto measurement, auto-focus, reporting, test program storage, and many more.

For the more advanced users, for whom the standard applications would not be sufficient, IMPRESSIONS™ 4 has an unmatched level of optional “apps” that can be installed as plugins, later, at any moment. During the purchase of your tester, decide on what you need at that moment. Widen your options at any moment by a simple e-mail and a few mouse clicks, to install optional functionality. As easy or simpler than installing an app on your mobile phone.

POWERED BY IMPRESSIONS v4

Next gen workflow & tester control...



Just buy a software release ticket, and your tester has added functionality, regardless where it is located. A revolutionary system taking care of all your needs. In this way we keep the learning curve, the process to work efficiently with our software limited to the level of “need to have” and “need to know”. The proportion of installed and activated software never needs to be more than your requirements.

On the higher end, IMPRESSIONS 4 connects flawlessly with quality control systems such as QDAS, exports files in CVS, XML or other formats and if your requirement is not standard, our team of engineers will efficiently find ways to handle your data properly. Bespoke solutions such as connectivity to robotic systems are standard solutions for INNOVATEST™.

Unique to IMPRESSIONS™ 4 is a choice for screen size and position. Whether you wish your interface to be in portrait mode or landscape, all functionality is supported in both positions. For table top solutions like testers in laboratories, users often opt for landscape screen(s).

On the shopfloor the large landscape screens are often an unwanted component either requiring a table top or machine mounted bracket taking a lot of space and cables to deal with. IMPRESSIONS 4 leaves you the option to go for landscape or for portrait mode on a large selection of our machines.

For the FALCON 500G2, INNOVATEST recommends the 27” industrial quality landscape screen operated by both touch as well as mouse and keyboard. One screen is standard included with the hardness tester, optional is the Dual view function, these are 2 x 24” industrial quality landscape screens. New applications are added to IMPRESSIONS™ on a regular basis; while INNOVATEST provides 10 years free updates, upgrades to more functionality or new additions can be purchased at any time.

TIME REDUCING SOFTWARE SOLUTIONS...

1 PATTERN EDITOR

The IMPRESSIONS™ pattern editor allows the user to create any number of test patterns with a large number of variable settings. Create test patterns with great precision and freedom. Verify the settings in the preview mode. Drag & drop patterns from one test sample to another sample. Live vision technique over zoom overview camera, no image stitching required.

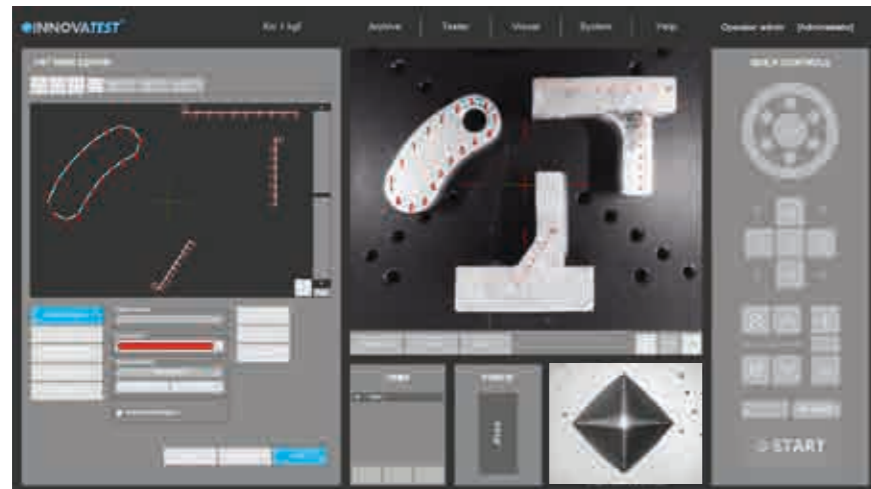

Combine different patterns and even different test forces in one program, and run them fully automatically. All test points can be identified individually or to customer specifications. The label is shown in the test result list and in the test results overview and in the results print out. An important function for sample analyses at the end of a test and in the future for review of previous tests.

2 CHD, SHD, NHD

How do you increase throughput in your lab? Make the most common testing design as easy to set up as possible to perform automatically and still adhere to the applicable standards. CHD/SHD/NHD testing can be started directly from the surface view or from the overview. Additional core points of hardness can be defined separately for NHD measurements.

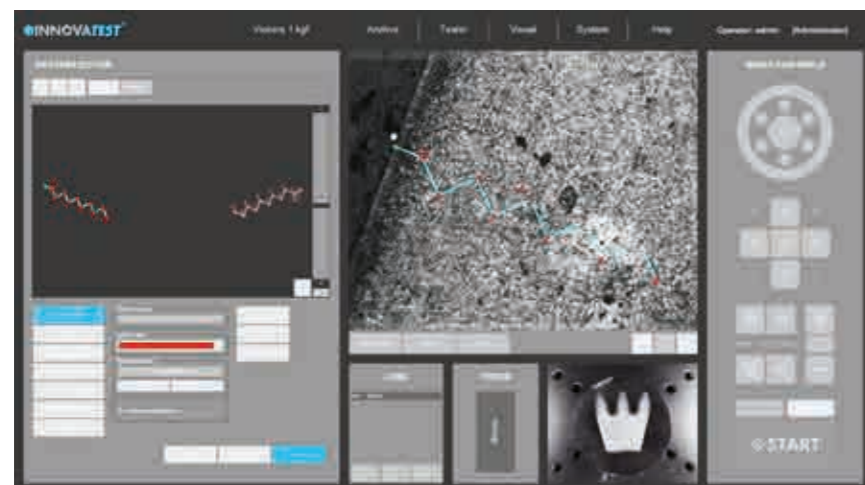

The distances of test points are automatically set to a minimum distance, following the standard, to assure correct testing is conducted. Time saving test mode "complete all indentations - then evaluate" and "auto-stop" to complete test series as soon as the lower hardness limit has been reached. Report Generator is enhanced with reporting features for this application.

3 WELD INSPECTION (ISO 9015)

This especially developed tool enables you to conduct hardness testing on welded parts or segments according to ISO standard. Setting up the pattern according to the requirements becomes "easy-to-do", due to pre-set test points in the different zones of the weld and automatic correlation between test points. The system will run a fully automatic test procedure and display and record the results accordingly. The Report Generator is enhanced with reporting features for this application.

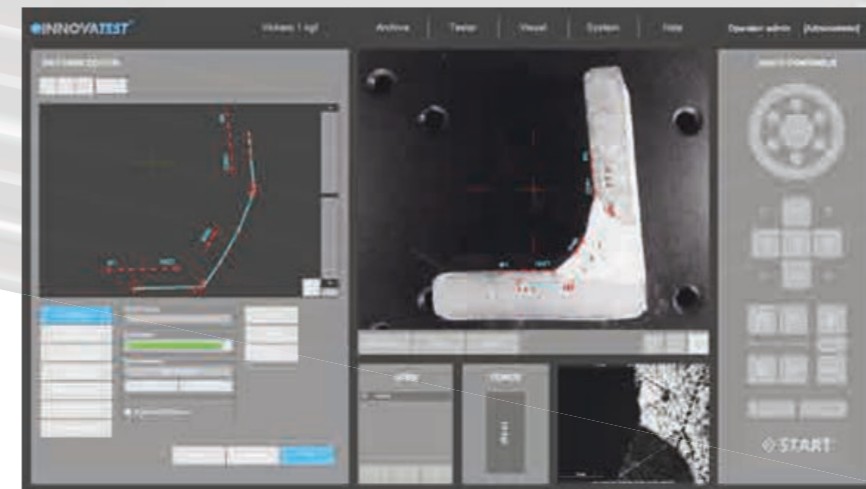

4 HARDNESS OF SCREW THREAD DECARBONIZED ZONE (ISO898-1)

A specialized software tool of IMPRESSIONS™ allows you to set up and conduct fully automatic testing as per ISO898-1 for screw thread measurement of (de)-carbonized part.



The Report Generator is enhanced with reporting features for this application.

5 EDGE DETECTION

Technology that automatically or at a mouse click recognizes the edge of your sample. This helps to determine and fix the desired starting position for CHD or other pattern testing jobs.

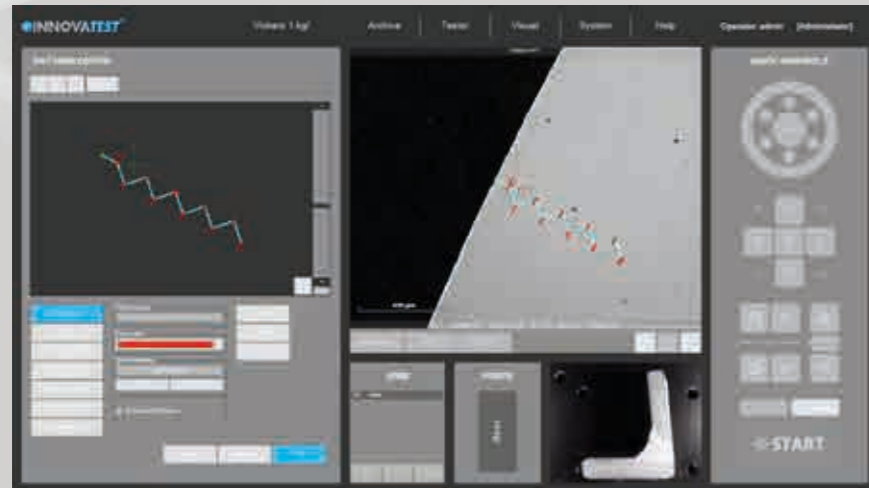

7 2D HARDNESS CHART

The application „Plane hardness chart“, is also referred to as Color Mapping happens to be the perfect tool for securing the detail of the effective hardness distribution over the total sample cross section of heat treated samples. An important feature in material exploration, weld testing or in damage analysis.

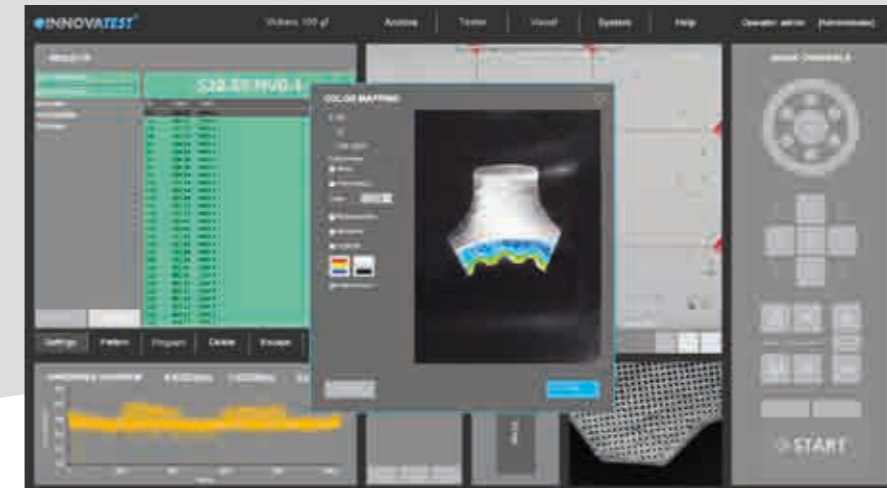

6 AUTOMATIC CONTOUR SCANNING

This application scans the entire outline (or partial) area of a sample. The function can be used with an objective by using the overview zoom camera for high speed scanning. The system scans the entire outline defined and stores all relevant data in the test program.

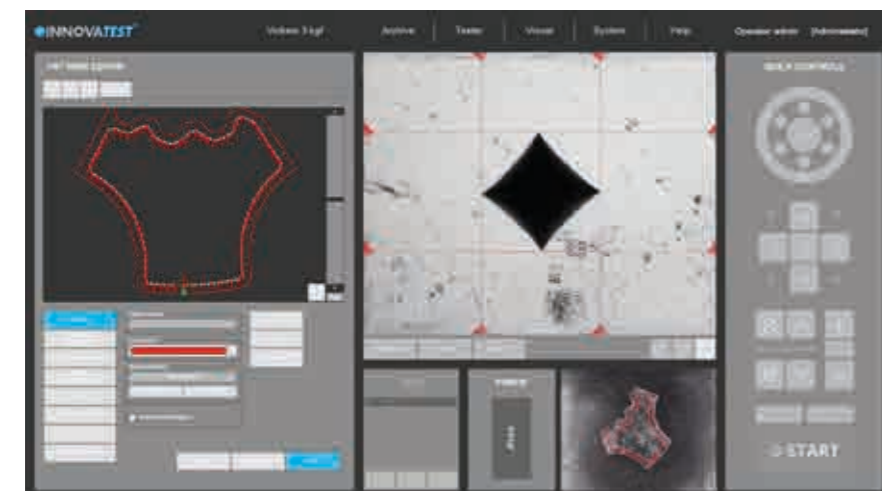

8 3D HARDNESS CHART

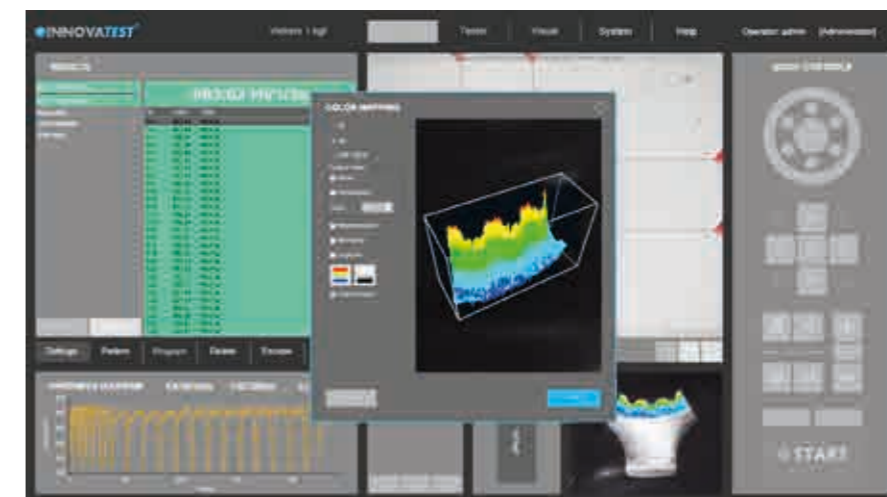

In addition to 2D graphic diagrams, the system can also automatically generate 3D diagrams. 2D and 3D hardness charts are included in one application.

Subsequently, a limitless number of test points can be inserted into the scanned image, or be set at selected distances (offset), relative to the edge. This advanced feature enables the hardness testing procedure to be performed c. An excellent featured combined with 2D or 3D hardness mapping, also known as “plane hardness chart”.

9 Kic CRACK MEASUREMENT

For those requiring more in depth knowledge on materials behavior, wishing to study material fracture and fatigue, crack growth can be predicted and measured by using the Kic application.

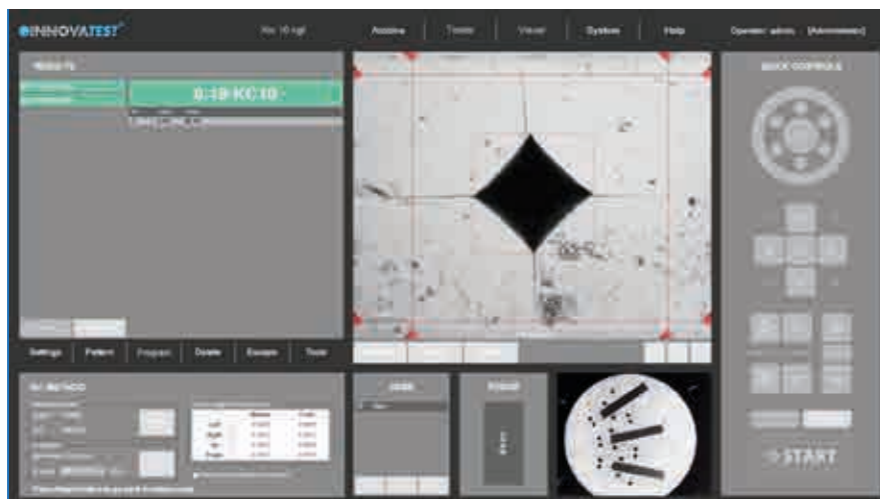

The software supports Kic crack detection under load with customized Kic result reporting. By way of one or both methods, Palmqvist or Median / Radial, fracture toughness is now a repeatable and reproducible test across multiple operators.

10 SNAPSHOT FUNCTION



This handy function in IMPRESSIONS™ allows you to make screen captures of the viewing area by way of objective view and/or Overview camera. It gives the opportunity to store such images with comments or to paste them into the report generator for further processing.

11 USER DEFINED PROGRAMS

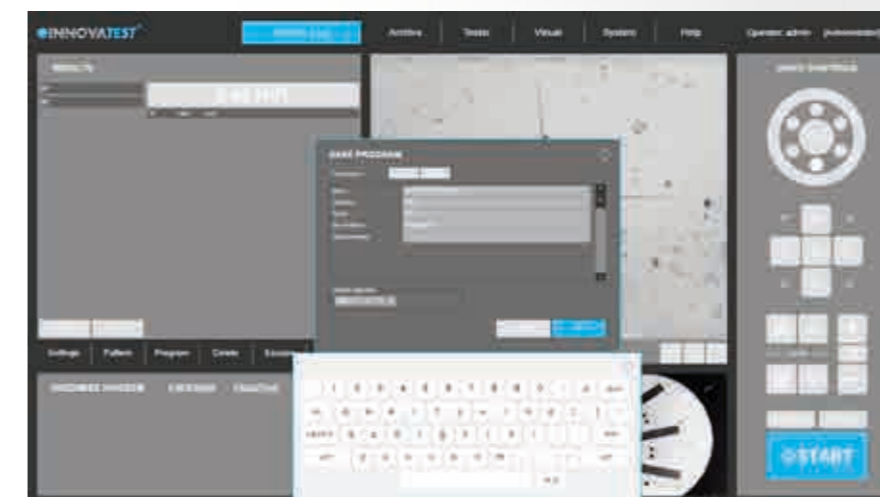

For repeating jobs, IMPRESSIONS™ utilizes the option of setting up and storing custom test programs. For each task, a "job" can be created. All application specific parameters, such as hardness scale, force, dwell-time, pattern, conversion and the report template are stored in the same program.

12 REPORT GENERATOR

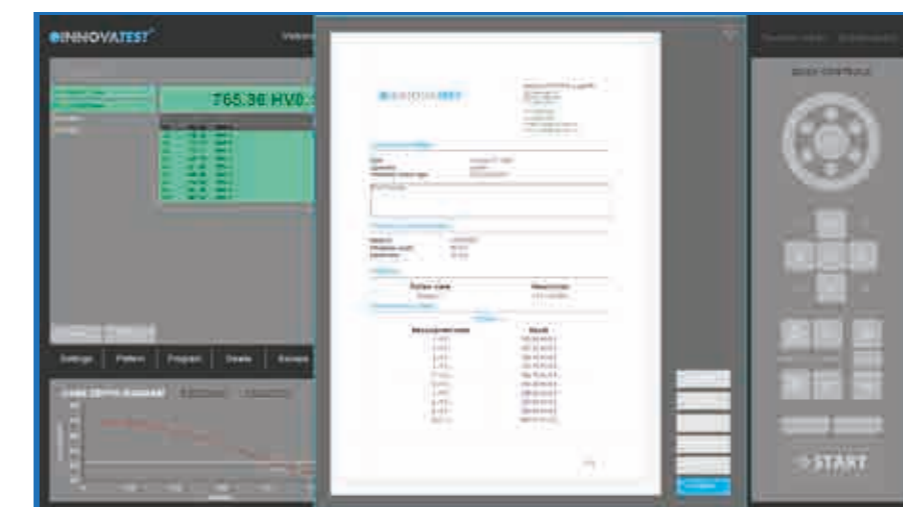

Imagine having a report created for you that includes: Your company name, address, contact information, labeled results related to patterns or sequential, pictures of your optical measurements, stitched images, notes section for each result or pictures, rendition of the pattern performed, overview picture of your pattern on your sample, full statistics, summary of your results, go no-go results, Pass or fail...

All this information or having the ability to only have what you need reported, we call this our Report Configurator. You decide how much or how little you report by PDF or laser printer. We even keep it simple by choosing export to CSV file, to a thumb drive or network file location. Data management at its best!

MONITORING

Our world is going through processes that have influence on climate and environment. More often we see extreme heat, extreme cold and periods of extreme rain. To assure that such disturbances of nature do not coincidentally effect your measuring or testing results, we have prepared our machines to climate change and forces of nature.

13 VIBRATION & EARTH QUAKE MONITORING



The integrated high precision accelerometer electronics continuously monitor your tester's stability environment. While the tester has vibration isolators (machine dampers) installation environment is often not ideal. Think of heavy traffic, loaded fork lift trucks, excentre presses or other equipment making shop floor installation a base of trouble.

For certain countries/area's in the world where light earthquakes are so common that they are hardly noticed, the vibration monitoring system will give a warning message and stop the hardness testing process to avoid incorrect readings.

14 TEMPERATURE & HUMIDITY MONITORING



Extreme high or low temperatures might not only effect the hardness readings of your machine (think of installation in extremely warm countries or nearby furnaces) extreme humidity might even damage the sensitive electronics.

IDENTIFICATION

- 15 The basic function of the barcode reader is to load data in to determined user fields. The BAR | QR code module of INNOVATEST connects the machine to a database or network environment loading samples and data.



Whether simply inserting header files (single or serial) or the complete integration of reading devices for the automatic selection of database templates, retrieving data from connected ERP or quality systems (optional) QR and barcode readers simplify complicated work procedures for the operator.

In the above application, a turbo part has been engraved with a QR code. Extra challenging was the fact that the QR code was engraved in a high polished part of the turbo shaft.

All data for the particular turbo part was fixed in the underlying QR code. The scanner loads all customer data in the hardness testing machine and assures that the testing outcome is included in the particular test report database, fully automatic.

METALLOSCOPE™

METALLOGRAPHY

SOFTWARE

The objectives on the 500G2 make the hardness tester into an excellent highly automated metallurgical microscope. Metallographic studies are of key importance in the manufacturing process of metals and steel, in the aerospace and automotive industry, in mechanical engineering, construction and in the manufacturing of a vast number of industrial and consumer products.

Microscopy is an indispensable feature of every metallographic lab, whether you investigate damages, develop novel alloy materials or perform quality control to ensure the purity of steel. The measurement of certain parameters such as volume fraction, coating thickness and grain size is specified in strict standards and norms.

Metallography is used to investigate metals from copper and titanium to iron, steel and alloys of every description. These investigations can now be performed quantitatively and reliably using the INNOVATEST Metalloscope™ 1 software module, running on most of our higher-end hardness testing machines*. *(features of Metalloscope™ 1 software depend on the particular tester model).

The microstructure of metals has a significant influence on properties such as strength and corrosion resistance. Therefore, a detailed investigation of the microstructure with the help of microscopy is central to metallographical disciplines as well as many industrial applications.

GRAIN SIZE



Grain size:
The grain size index can be calculated in various 1 or 2 dimensional way; using a 1-dimensional method (from the number of grain intercepts per mm) or a 2-dimensional method (from the number of grains per mm²). Line profile: 1-dimensional grain size index calculation by counting the number of grain intercepts on a line. Hexagonal grid: 2-dimensional grain size index calculation using a superimposed hexagonal grid or single grains calculation by counting the number of grains in a specific part of the image (blue box).

Hardness tester and metallurgical microscope.

Basic metals undergo specific treatment in order to prepare them for particular applications and to improve their characteristics, for example by adding alloying elements. In many cases, the microscopy investigation focusses on the correlation between the resulting microstructure and the material properties.

VOLUME FRACTION



Volume fraction:
Various methods integrated; the example shows a sample consisting of ferrite (black material) and austenite (white material). Pixel counter: calculation based on histogram-guided image thresholding. Two automatic thresholding algorithms in addition to manual thresholding. Grid counter calculation using a superimposed grid. Each grid point can be assigned to the black material or white material. Initial values (black or white) are assigned automatically, but can be toggled manually. Grid positions are calculated by defining the number of grid points or the grid spacing.

COATING THICKNESS

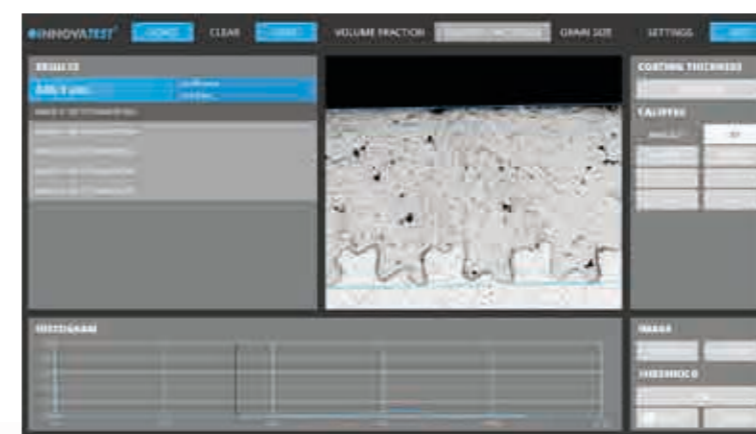

Coating thickness:
Calculate the thickness of a coating layer. This can be a single thickness or a mean thickness with standard deviation or a coating contour. Calculation using two parallel lines. The resulting coating thickness is the distance between these lines. Calipers can be rotated, automatic or manual. Coating contour: coating thickness calculation based on a number of measurement points. Contour edges are drawn semi-automatically and the number of measurement points can be selected by the user.

The FALCON 500G2 is basically an upright, brightfield and darkfield microscope. Contrast methods of reflected light brightfield result are best suited to analyze the microstructures of etched surfaces. Recognizing grain boundaries, you can draw conclusions on grain sizes, phases and structural constituents. Impurities and structural constituents, such as graphite in cast iron, prior to etching are getting visible.

Reflected light darkfield shows up mechanical surface faults such as fracture sites, pores and inclusions as well as cracks, scratches and cavities. In combination with the FALCON 500G2 automation, the system provides in maximum efficiency for both hardness testing and materials inspection.



VARIOUS POSSIBILITIES

The FALCON 500G2 is designed in such a way for the large selection of fixtures and specimen holders to be used on the CNC XY-stage. The frame size allows a large workspace accommodation. Regardless of the shape of a particular workpiece, the accessories list and corresponding software applications enable to test almost any component and part.

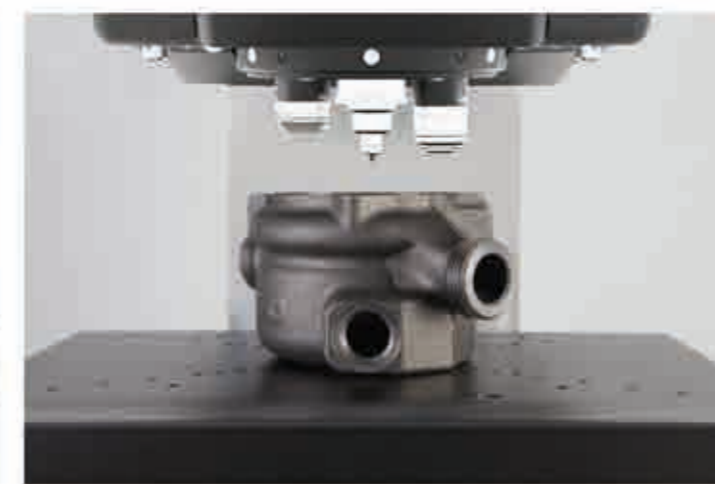



STEP 1: Select the machine



STEP 2: Force range

- OPTION 1 5gf -2kgf
- OPTION 2 10gf -2kgf
- OPTION 3 10gf -10kgf
- OPTION 4 10gf - 31.25kgf
- OPTION 5 10gf - 62.5kgf
- OPTION 6 200gf - 62.5kgf

- EXTENSION A 0.1gf -1gf
- EXTENSION B 1gf - 10gf
- EXTENSION C 10gf - 200gf
- EXTENSION D 2kgf - 10kgf
- EXTENSION E 10kgf - 31.25kgf
- EXTENSION F 31.25kgf -62.5kgf

STEP 3: Indenters

- 1 Indenters
 - A Vickers
 - B Knoop
 - C Brinell

STEP 4: Optical

- 2 Eyepiece
- 3 Overview camera
- 4 Objectives
 - x25
 - x5
 - x10
 - x20
 - x50
 - x100
- 5 Ringlights
 - A
 - B

STEP 5: Stages/Anvils

- 6 Stages
 - A
 - B
 - C
 - D
 - E
 - F
 - G
- 7 Anvils
 - A
 - B
 - C
 - D
 - E

STEP 6: Sample holders

- 8 Sample holders
 - A
 - B
 - C
 - D
 - E
 - F
 - G 25 mm
 - H 30 mm
 - I 40 mm

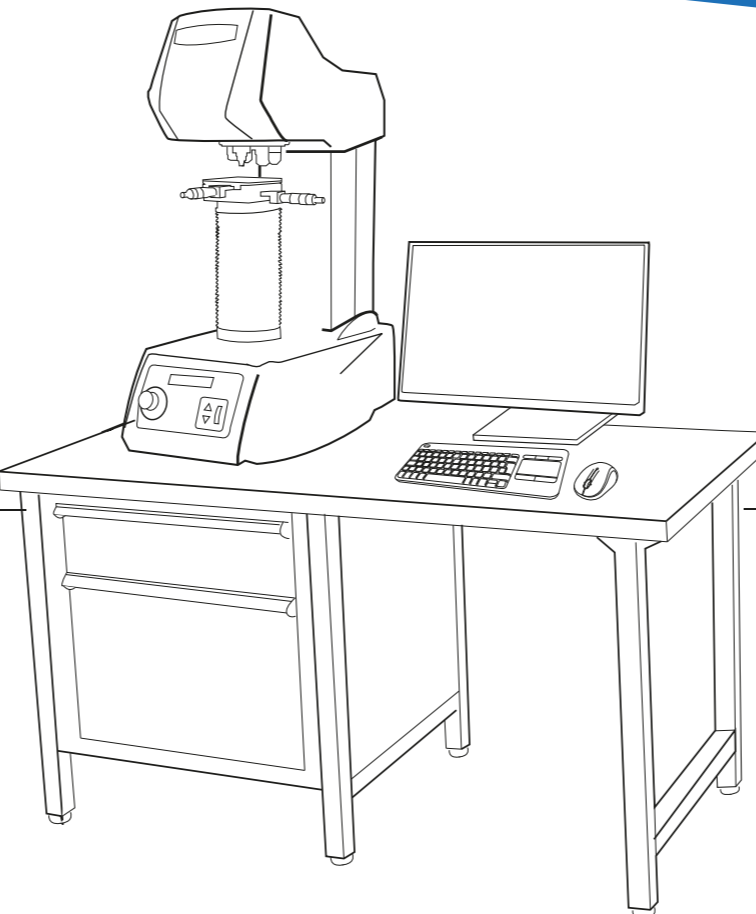

STEP 7: Fixtures & Vices

- 9 Fixtures & Vices
 - A
 - B
 - C
 - D
 - E
 - F
 - G
 - H
 - I
 - J

STEP 8: Software

- MANUAL ON-SCREEN MEASUREMENT
- AUTOMATIC MEASUREMENT
- AUTOMATIC FOCUSING
- REPORT GENERATOR
- SNAPSHOT FUNCTION
- VIDEO OVERLAY PATTERN EDITOR
- IMAGE STITCHING
- KIC CRACK MEASUREMENT
- AUTOMATIC CONTOUR SCANNING
- 2D / 3D HARDNESS CHART
- DRAWING & MEASURING APPLICATION
- DUALVIEW TECHNOLOGY
- AUTOMATIC EDGE DETECTION
- HARDNESS OF SCREW THREAD (ISO 898-1)
- HARDNESS OF TAPPING SCREWS (ISO 2702)
- USER LEVEL MANAGEMENT
- CHD, SHD, NHD CONFIGURATOR
- Q-DAS
- AMMUNITION TESTING PATTERN
- WELD INSPECTION (ISO 9015)
- VIBRATION, TEMPERATURE & HUMIDITY MONITORING
- AI SOFTWARE
- BARCODE & QR SOLUTIONS
- METALSCOPE SOFTWARE

✓ = Standard included

ORDER DETAILS

FALCON 500G2



FALCON 500G2 Micro hardness tester, IMPRESSIONS™ 4	FALCON 500G2	
OPTION 1: Force range fixed 5gf - 2kgf (can not be extended)	SLFFG201	
OPTION 2: Force range 10gf - 2kgf	SLFRG202	
OPTION 3: Force range 10gf - 10kgf	SLFRG203	
OPTION 4: Force range 10gf - 31.25kgf	SLFRG204	
OPTION 5: Force range 10gf - 62.5kgf	SLFRG205	
OPTION 6: Force range 200gf - 62.5kgf	SLFRG206	
Extension A: Force range extension 0.1gf - 1gf (requires extension B)	SLFRG2A	
Extension B: Force range extension 1gf - 10kgf	SLFRG2B	
Extension C: Force range extension 10gf - 200gf	SLFRG2C	
Extension D: Force range extension 2kgf - 10kgf	SLFRG2D	
Extension E: Force range extension 10kgf - 31.25kgf	SLFRG2E	
Extension F: Force range extension 31.25kgf - 62.5kgf	SLFRG2F	
Indenter actuator post (2nd indenter position) factory installed	SA-70-0003	
Dual optical channel, electronic microscope and camera system, can be used simultaneously	SA-70-0004	
Plug & Play prepared, calibration, sea & airworthy packing in "non coniferous wood" material	P&PSEAPACK30	

ACCESSORIES

STEP 3		Indenters			
1	Vickers	A	Micro Vickers Indenter Ø3mm ISO/ASTM certified	UPI/8105	
	Knoop	B	Micro Knoop Indenter Ø3mm ISO/ASTM certified	UPI/8205	
	Brinell	C	Brinell Indenter 1mm. Includes 1 carbide ball. Ø3mm. ISO & ASTM certified	UPI/7001	
			Brinell Indenter 2.5mm. Includes 1 carbide ball. Ø3mm. ISO & ASTM certified	UPI/7006	
			Brinell Indenter 5mm. Includes 1 carbide ball. Ø3mm. ISO & ASTM certified	UPI/7011	
STEP 4		Optical			
2	Eyepiece		Electronic digital eyepiece with 15x magnification	AS-EYEPIECE/03	
3	Overview Camera		HD Overview camera. Full view zoom camera + software functionality	SA-05-0051	
4	Objectives		2.5x Long Working Distance objective	ASSUN-OBJ2.5X	
			5x Long Working Distance (LWD) objective	BM-05-0001	
			10x Long Working Distance (LWD) objective	BM-05-0002	STANDARD
			20x Long Working Distance (LWD) objective	BM-05-0003	
			50x Long Working Distance (LWD) objective	BM-05-0004	STANDARD
			100x Long Working Distance (LWD) objective	BM-05-0005	
5	Ring lights	A	Crystal™ Clear LED ring light, multi use for 2.5x objectives	SA-05-0021	
		B	Crystal™ Clear LED ring light, multi use for 5x objectives	SA-05-0013	

STEP 5		Stages/Anvils			
6	Stages	A	Manual X-Y stage with analogue metric micrometers, 100x100mm Displacement: 25x25mm, scale 0.01mm, max load 60kg	UN-XYSTAGE/115	
			Manual X-Y stage with analogue metric micrometers, 100x100mm Displacement: 25x25mm, scale 0.01mm, max load 100kg	UN-XYSTAGE/120	
			Mounting plate	AS500XL-450-02	
		B	Digital micrometer, for manual X-Y stage, Displacement: 25mm, resolution 0.001mm	IMP-DIGMIC	
			Manual iSMART™ stage, 150x150mm, Displacement: 50x50mm	BM-08-0057	
		D	Digital control unit for Manual iSMART™ stage, 25mm travel	BM-08-0058	
			Digital control unit for Manual iSMART™ stage, 50mm travel	BM-08-0059	
		E	Manual X-Y stage with analogue metric micrometers, 180x160mm Displacement: 25x25mm, scale 0.01mm, max load 300kg	UN-TESTTABLE/030	
			Manual X-Y stage connecting plate	UN-TESTTABLE/030FAPL	
		F	Motorized CNC X-Y stage, 257x188mm, total load up to 400Kgf max Displacement: 120x120mm, resolution 0.001 mm, repeatability +/-0.003mm	UN-XY571212TT	
			Motorized CNC X-Y stage, 357x208mm, total load up to 400Kgf max Displacement: 220x120mm, resolution 0.001mm, repeatability +/- 0.003mm	UN-XY572212TT	
		G	iSMART™ motorized CNC X-Y stage, 215x160mm, total load up to 400Kgf max. Displacement: 75x75mm, resolution 0.001mm, repeatability +/-0.0015mm	MA-XY7575S	
			iSMART™ stage, 260x205mm, total load up to 400Kgf max. Displacement: 120x120mm, resolution 0.001mm, repeatability +/-0.0015mm	MA-XY1212S	
			iSMART™ stage, 360x205mm, total load up to 400Kgf max. Displacement: 220x120mm, resolution 0.001mm, repeatability +/-0.0015mm	MA-XY2212S	
			<i>Cable sets, mounting & Connectivity for motorized stage</i>	Cable set for connecting CNC stage to embedded driver (1 set for 2-axis) 105cm	UN-XY2CABLENBS
		iSMART™ X-Y stage connection cable	CE-99-0030		
7	Anvils	A	V block with bracket 40x40x50mm (LxBxH)	UN-VBLOCK404050	
			Steel, cross type, (X) V-block 60x120x100mm 8-90mm pair	UN-CROSSBLOCK01	
			Small V-Anvil 3-20mm requires base plate (Requires Manual/Autom. X-Y stage)	UN-ANVILSV/105	
			Large V-Anvil 20-75mm requires base plate (Requires Manual/Autom. X-Y stage)	UN-ANVILLV/106	
			Base plate for V-anvils un-anvilsv/105 & 106	UN-VANVILBASEPL	

STEP 6		Sample holders			
9	Sample holders	A	1 position sample holder, for 1 embedded sample, diameter 50mm or 2"	UN-ESH1	
		B	4 position sample holder, for max. 4 embedded samples, diameter 50mm or 2"	UN-ESH4	
		C	6 position sample holder, for max. 6 embedded samples, diameter 50mm or 2"	UN-ESH6	
		D	1 position sample holder, for 1 embedded sample, diameter 50mm or 2" with front operation elevator knob	BM-08-0052	
		E	4 position sample holder, for max. 4 embedded samples, diameter 50mm or 2" with front operation elevator knob	BM-08-0053	
		F	6 position sample holder, for max. 6 embedded samples, diameter 50mm or 2" with front operation elevator knob	BM-08-0054	
		G	1 insert reduction ring 25mm	UN-ESHI25	
		H	1 insert reduction ring 30mm	UN-ESHI30	
		I	1 insert reduction ring 40mm	UN-ESHI40	
			1 insert reduction ring 1"	UN-ESHI1	
			1 insert reduction ring 1 1/4"	UN-ESHI125	
			1 insert reduction ring 1,5"	UN-ESHI15	
STEP 7		Fixtures & vices			
	Fixtures & vices	A	Polished precision vice with lock down system, jaw width 25mm, opens 20mm	UN-VICE/210	
		B	Polished precision vice with lock down system, jaw width 36mm, opens 42mm	UN-VICE/215	
		C	Polished precision vice with lock down system, jaw width 48mm, opens 75mm	UN-VICE/220	
		D	Polished precision vice with lock down system, jaw width 75mm, opens 100mm	UN-VICE/230	
		E	Axle chuck 500 series for cylinder parts, dia. 0.4mm to 5mm	UN-AXLECHUCK	
		F	Universal Clamp & Leveling Device	UN-CLAMP/105	
		G	Thin metal clamp	UN-CLAMP/115	
		H	V groove clamp for small round parts dia.0.8-5mm	UN-VGROOVE-CLAMP	
		I	Wire Testing Fixture for specimen dia. 0.8-3.5mm	UN-WIRE/105	
		J	Small parts vice jaw width 55mm, open 50mm, self centering	UN-VICE/115	
STEP 8		Software			
	Additional Software		Manual on-screen measurement	UN-MANM	STANDARD
			Automatic measurement	UN-AUTOM	STANDARD
			Automatic focussing	UN-AUTOFOC	STANDARD
			Report configurator	UN-REPORTA	STANDARD
			Snapshot function	UN-SNAPSH	STANDARD
			Advanced 3 axis coordinate & free style indent pattern configurator, for motorized stage only	UN-TESTPAT01	
			Advanced 3 axis coordinate & free style indent pattern configurator, + CHD, SHD, NHD and edge detection, (supports manual & digital micrometer stages only)	UN-TESTPAT02	
			Image stitching, composes full stage overview, and detailed sample overview. High resolution magnification of designated test area. Requires a motorized stage.	UN-IMST01	
			KiC crack detection under load. Palmqvist & Median / Radial fracture toughness	UN-CRKPAP	
			Automatic Contour scanning	UN-CSCAN	
			2D / 3D hardness scanning (mapping, includes automatic contour scanning)	UN-CSCAN2D3D	
			Drawing and measuring (distance & angles) application	UN-DRMEAS	

		DualView Technology, 2 viewing screens software, screen, cables, Europe and US power cable included, 2x 24 "Industrial LCD screens included	UN-DVTECHSET24	
		Automatic edge detection	UN-EDGEDTC	
		ISO 898-1 screw thread measurement of (de)-carbonized part (requires UN-CSCAN)	UN-ISO898/1	
		ISO-2702 tap screw thread measurement	UN-ISO2702	
		User level management	UN-LEVMAN	STANDARD
		CHD, SHD, NHD configurator & graphic interface for analogue and digital micro meter stage only (not including full pattern editor)	UN-MCHD	
		CHD, SHD, NHD configurator & graphic interface requires: indent pattern configurator (TESTPAT01)	UN-PATCHD	
		Q-DAS Certified connectivity protocol	UN-QDAS	
		Advanced 3-axis communication protocol for robotic systems	UN-REMC	
		ISO bullets casings pattern configurator and reporting system	UN-SHELLCONF	
		ISO 9015 Weld pattern configurator (automatic weld pattern configurator), requires overview camera or AS9000-0.7OBJ	UN-WELDPAT	
		Vibration, temperature & humidity monitoring	UN-VIBCLC	
		Artificial Intelligence Deep Learning Brinell module	UN-AIDLB01	
		Barcode & QR data mapping software	UN-SCANFLOW	
		Metalloscope™ Metallography software pack	UN-MSCPV1	
	Connectivity Plus	Powerful external intel core i7 pc, with 16gb ram, and 512gb ssd drive Windows 10 pre-installed including wiring and integration with tester.	UN-SYSPCIMP01	
		Powerful external intel core i9 pc, with 16gb ram, and 512gb ssd drive Windows 10 pre-installed including wiring and integration with tester.	UN-SYSPCIMP02	
		Utility software; Import test results in MS applications like Excel	UN-SW/905	
		Bluetooth connectivity	UN-BTADAPT	
		Wireless system Keyboard & wireless mouse	UN-SKBSET	STANDARD
		Virtual joystick, on-screen		STANDARD
	Additional items			
	Machine stands	Cabinet test table with drawer for hardness testers 71x75x80cm	UN-STAND/960	
		Cabinet test table with drawer for hardness testers 150x75x80cm	UN-STAND/965	
		Seaworthy packing box for 950/960	PACK/100	
		Seaworthy packing box for 965	PACK/200	
	Vibration isolation stage	Passive vibration isolation stage, broad spectrum	UN-AVS-150	
		Limit switch relocater	AS500XL-150-16	STANDARD
	Printer	Laser Printer	UN-PRINT	
	Projector	On request, any brand of choice	UN-PROJECTOR	
	Machine cover	Machine cover 350x550x770mm	UN-COVER1	
	CE Automation safety cabin	Front access safety cabin with light shield. Machines controls positioned outside cabin. External connectors for screen, keyboard etc.	SA-27-0002	
	ISO 17025 UKAS	UKAS EN ISO 17025 Direct/Indirect calibration report	CCERTFEE/UKAS	
	ISO 17025 UKAS ISO / ASTM Calibration	BRINELL direct and indirect calibration & certification, traceable, in compliance with ISO & ASTM, NADCAP. Flat fee for selected common scales, per scale.	CCERTUKAS/1B	
	ISO 17025 UKAS ISO / ASTM Calibration	VICKERS direct and indirect calibration & certification, traceable, in compliance with ISO & ASTM, NADCAP. Flat fee for selected common scales, per scale.	CCERTUKAS//1V	
	ISO 17025 UKAS ISO / ASTM Calibration	KNOOP direct and indirect calibration & certification, traceable, in compliance with ISO & ASTM, NADCAP. Flat fee for selected common scales, per scale.	CCERTUKAS/1K	

ACCESSORIES

INDENTERS

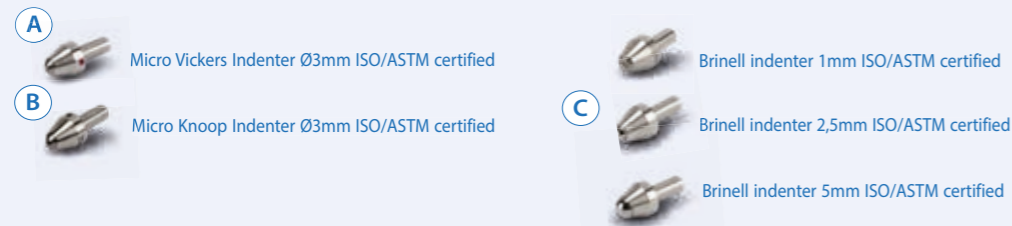

OPTICAL

Eyepiece



AS-EYEPIECE/03

Objectives



Overview camera



SA-05-0051

Ringlights

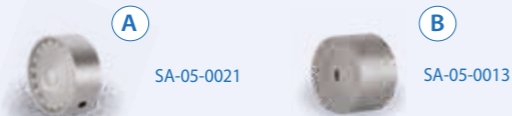

STAGES/ANVILS

Stages



Anvils



SAMPLE HOLDERS

Sample holders - Regular model

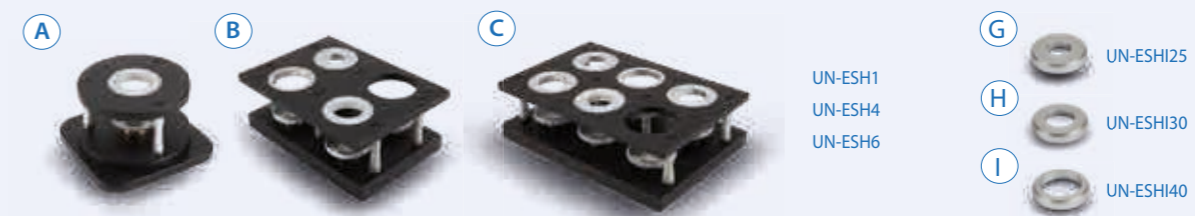

Sample holders - Front operation



FIXTURES & VICES

Fixtures & vices



SAFETY CABIN



SPECIFICATIONS

HARDNESS SCALES

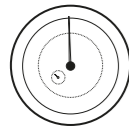
	VICKERS ISO 6507 ASTM E384, E92 JIS B 7725 *Extended range	HV0.001 HV0.002 HV0.003 HV0.004 HV0.005 HV0.006 HV0.007 HV0.008 HV0.009 HV0.010 HV0.015 HV0.020 HV0.025 HV0.050 HV0.1 HV0.2 HV0.3 HV0.5 HV1 HV2 HV2.5 HV3 HV4 HV5 HV10 HV20 HV25 HV30 HV40 HV50 HV60 *(HV0.0001 - HV0.0009 increases with steps of HV 0.00005)
	Kic Fracture toughness	All Vickers forces & scales
	KNOOP ISO 4545 ASTM E92 JIS Z 2251	HK0.001 HK0.002 HK0.003 HK0.004 HK0.005 HK0.006 HK0.007 HK0.008 HK0.009 HK0.010 HK0.015 HK0.020 HK0.025 HK0.050 HK0.1 HK0.2 HK0.3 HK0.5 HK1 HK2 HK2.5 HK3 HK4 HK5
	BRINELL ISO 6506, ASTM E10 JIS Z 2243	HBW1/1 HBW1/1.25 HBW1/2.5 HBW1/5 HB1/10 HBW1/30 HBW1/31.25 HBW2.5/6.25 HBW2.5/7.8125 HBW2.5/15.625 HBW2.5/31.25 HBW2.5/62.5 HBW5/25 HBW5/31.25 HBW5/62.5
CONVERSIONS	Conversion to other hardness scales according to ASTM E140, ISO 18265, GB/T 1172	

TEST FORCE

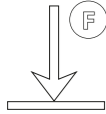
	Force application	Multi-load cell, closed loop, force feedback system
	Force range	0.1gf – 62.5kgf
	Test force tolerance	< 0.25% for test force 100gf to 62.5kgf < 0.5% for test force below 100gf
	Dwell time settings	Default 10 seconds, user defined. Up to 250 seconds

TURRET

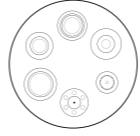
	Motorized turret	Ultra-fast, 6 position turret, 2 indenter positions, 4 objective positions
	Objectives	Long working distance 2.5x, 5x, 10x, 20x, 50x, 100x
	Indenters	Certified indenters (ISO/ASTM) available at choice
	Camera 1 (objective)	11 Mpx, HD, Machine vision system
	Camera 2 (overview)	Full HD, Optical zoom system, variable FOV 40 x 30 - 150 x 110mm

SYSTEM

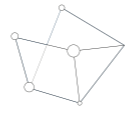
	Electronic system Standard (Recommended)	High performance embedded controller, i7, mSSD 120 GBxx, MS Windows® 10 operated, up to 8 years* INNOVATEST warranty
	Electronic system (Optional)	High performance external controller, i7 or i9, mSSD 120 GBxx, MS Windows® 10 operated, 1 year factory warranty
	CNC support	CNC controller (for motorized stages) or stage accessories
	Screen(s)	27" landscape mode capacitive touchscreen, second screen option
	Display resolution	0.01 HV, HK, HB
	Statistics	Total test, max, min, average, range, standard deviation, All in real time after each test
	Hardness conversion	Rockwell, Rockwell Superficial, Vickers, Brinell, Knoop, Leeb & Tensile
	Software	IMPRESSIONS™ V4, work flow system & tester control
	Data storage capacity	Internal and external mSSD, SSD or HDD
	Data output	XML, CSV, Certified for Q-DAS (Optional)
	Connectivity	5 USB ports, RJ45 Ethernet LAN, W-LAN, RS-232, Blue Tooth, 5 Axis CNC & motorized X-Y stage connector, Dual HDMI screen connectors
	Printer	A4, A3 full color laser printer (optional)

GENERAL

	Machine dimension	775 mm x 351 mm x 528 mm
	Workpiece accommodation	200mm (H) x 170mm (D)
	Machine weight	101 kg
	Power supply	100VAC to 240VAC, 50/60Hz, single phase
	Operating temperature	10°C to 35°C
	Power consumption	100W
	Humidity	10% to 90%, non-condensing

* Check individual warranty conditions

TECHNICAL DRAWINGS

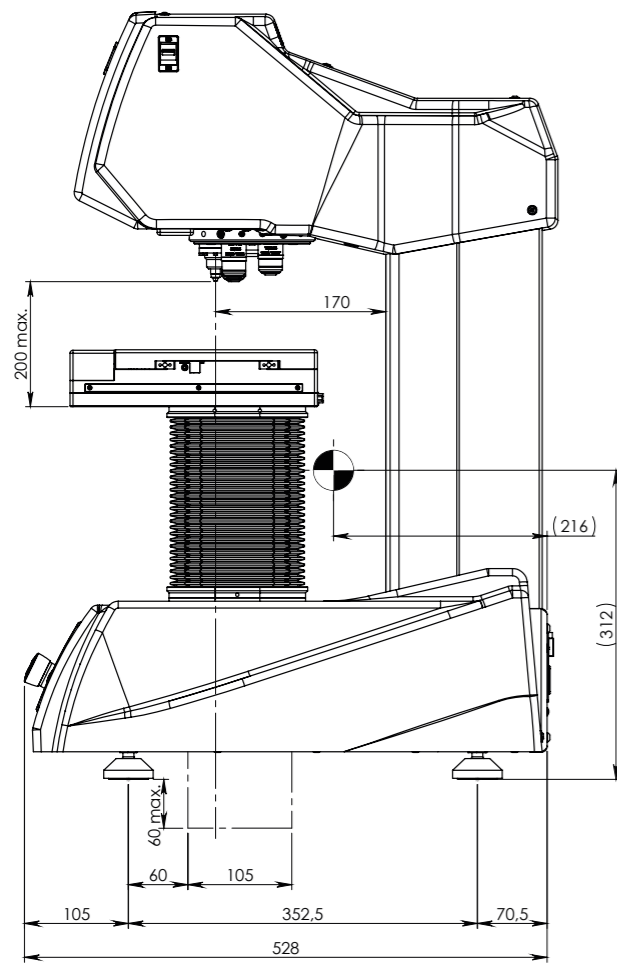

All dimensions in these drawings are in mm, approximate. Working heights and or workpiece accommodation varies depending on the stages and stage accessories used.

Please contact our sales department for more details.

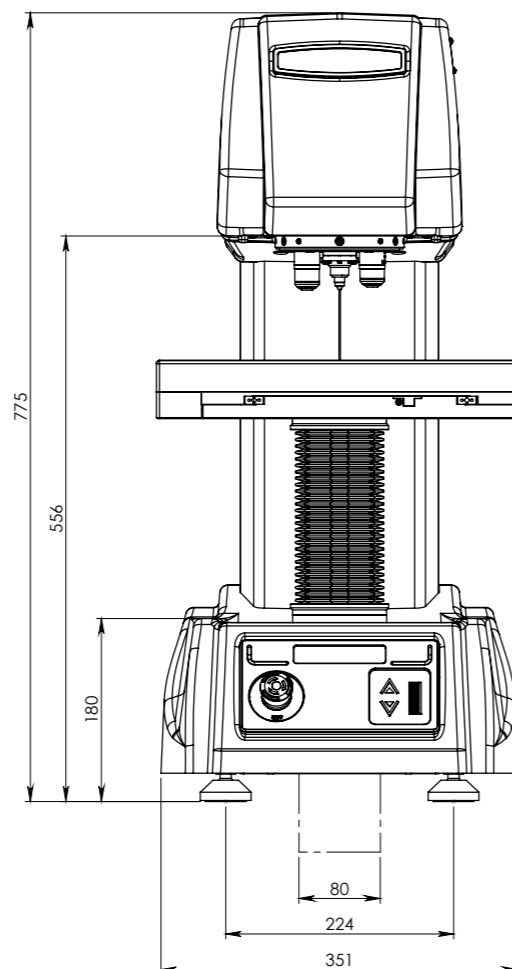

OTHER MODELS IN THE FALCON RANGE



FALCON 400G2

Load Cell, Closed loop
Micro/Macro Vickers, Knoop
& Brinell Hardness testers
With fine adjustable Z-axis
side handwheel
See brochure B22F400G2/XX



FALCON 450G2

Load Cell, Closed loop
Macro/Micro Vickers, Knoop
& Brinell Hardness tester
With Z-axis handwheel
See brochure B18F450/XX



FALCON 600G2

Multi Load Cell, closed loop
Fully automatic, free to
configure Micro/Macro Vickers,
Knoop & Brinell Hardness
testers. With ball screw
motorized Z-axis
See brochure B22F600G2/XX



FALCON 5000G2

Multi Load Cell, closed loop
Fully automatic, 8 position
turret, laser positioning.
Micro/Macro Vickers, Knoop
& Brinell Hardness testers.
Descending test head,
fixed work piece position
See brochure B22F5000G2/XX

Changes in products and/or product specifications can emerge due to new technologies and continuous development.

We reserve the right to change or modify specifications of the products without prior notice. We recommend you to contact our sales office for up-to-date information.

Brochure B22F500G2/04/EN

EUROPE

INNOVATEST Deutschland GmbH.
Sales & Service
Phone: +49 245 670 59 500
info@innovatest-deutschland.com
www.innovatest-deutschland.com

INNOVATEST France SARL
Sales & Service
Phone: +33 1 848 88038
commercial@innovatest-france.com
www.innovatest-france.com

INNOVATEST UK Ltd.
Sales & Service
Phone: +44 (0) 121 824 4775
info@innovatest-uk.com
www.innovatest-uk.com

INNOVATEST Polska sp. z o.o
Sales & Service
Phone: +48 697 099 826
info@innovatest-polska.pl
www.innovatest-poland.com

MIDDLE EAST

INNOVATEST Middle East LLC
Sales & Service
Phone: +971 56 372 6114
info@innovatest-mideast.com
www.innovatest-mideast.com

NORTH-AMERICA

INNOVATEST USA Inc.
Sales & Service
Phone: +1 267 317 4300
info@innovatest-usa.com
www.innovatest-usa.com

ASIA

INNOVATEST Shanghai Co., Ltd.
Sales & Service
Phone: +86 21 60906200
Fax: +86 21 60912595
info@innovatest-shanghai.com
www.innovatest-shanghai.com

INNOVATEST Japan K.K.
Sales & Service
Phone: +81 3 6667 0554
Fax: +81 3 6667 0556
info@innovatest-japan.com
www.innovatest-japan.com

INNOVATEST South East Asia
Sales & Service
Phone: +65 6451 1123
Fax: +65 6452 1011
info@innovatest-singapore.com
www.innovatest-singapore.com

Distributor :

CORPORATE HEAD OFFICE

INNOVATEST Europe BV
Manufacturing, Distribution & Service
Borgharenweg 140
6222 AA MAASTRICHT
The Netherlands

Phone: +31 43 3520060
Fax: +31 43 3631168
info@innovatest-europe.com
www.innovatest-europe.com