

FALCON 300G2

AUTOMATIC HARDNESS TESTER

VICKERS, MICRO VICKERS & KNOOP



FALCON 300G2

Traditional technology reinvented...

The FALCON 300G2 improves on the conventional hardness testing methods by focusing on elimination of user influence on the test results. The advanced force sensor technology utilizes an electronically controlled loadcell closed loop system with force feedback to achieve absolute accuracy, reliability and repeatability, on all of the forces used for a testing.

The innovative software functions of integrated I-TOUCH™ workflow control, allows file storage, test program setting and storing, limit settings, conversions to other hardness scales, system setup and convex and concave sample test settings that contribute to the exceptional repeatability and reproducibility of test results.



LOADCELL, CLOSED LOOP FORCE APPLICATION

1gf	5gf	2kgf	FALCON 300G2	31.25kgf
-----	-----	------	---------------------	----------

HIGHLIGHTS

- 1 Multi Load Cell, Closed Loop force application system, error <0.5%
- 2 6-position collision protected turret, 2 indenter positions; 4 LWD objectives positions
- 3 Analogue or electronic digital eyepiece - view via eyepiece and camera simultaneously
- 4 Full color industrial 6.5" touchscreen interface with I-TOUCH™ firmware
- 5 Powerful embedded electronic system
- 6 5 Mega pixels, Full HD+, integrated camera system (optional)
IMPRESSIONS™ XT indent evaluation and machine automation software
- 7 Top-class replaceable body parts, shock proof ABS covers



HARDNESS SCALES



VICKERS 5gf - 2kgf



KNOOP 5gf - 2kgf

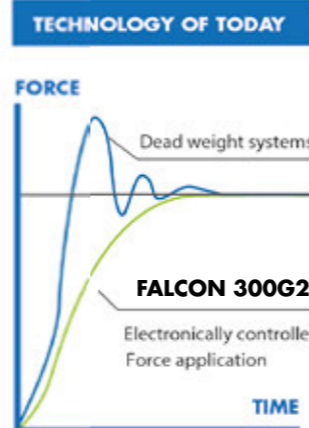

Load cell, closed loop,
force feedback system

ADVANCED INNOVATION



Unique machine structure

Rigidity and perpendicular indenter positioning are crucial to obtain Vickers indents with a perfect geometry. With a workpiece accommodation of 150 mm x 170 mm the FALCON 300 can be routinely used to conduct common and advanced testing tasks.

Above the current...

1 6 POSITION PRECISION TURRET

The 6 position turret is supplied as a standard feature on all 300 models and allows to install indenters for Vickers, Knoop and Brinell (balls 1mm & 2,5mm) testing. The precision mechanics of the motorized turret permit super-fast and quiet positioning. Switching between indenter and objective is part of the automated test cycle. The turret offers up to 6 positions, with maximum 2 indenters, and 4 objective positions allowing you to fit all the magnification power for your application.

2 ANALOGUE OR DIGITAL EYEPIECE AND BUILT-IN CAMERA

The FALCON 300G2 can be equipped with an analogue eyepiece or a digital eyepiece based on your requirements. An installation of both eyepieces is also possible. A HD camera for On SCREEN measurements in combination with the optional IMPRESSIONS™ software system can be installed at any moment. By accommodating the camera inside the head cover, it is protected against dirt and accidental damage or misalignment.

3 COLLISION DETECTION

To avoid any collision between the work piece and the turret, the turret has an overload protection. So neither the tester nor the workpiece are exposed to any damage.

4 XY-STAGES

The FALCON 300G2 is equipped with an adjustable manual stage that can carry up to 60kg load, perfectly fitted for quick and easy single test. Optionally the FALCON allows to expand to a wide choice of anvils and test tables. The IMPRESSIONS™ tester control and workflow software has many advanced positioning functions, from single indent to advanced pattern testing.

5 6.5" FULL COLOUR HD TOUCHSCREEN, I-TOUCH™

All machine control and process workflow can easily be operated from the 6.5" full-color HD touchscreen. Due to its angled position the display can be read in either standing or sitting position.



6 SHOCK RESISTANT ABS MACHINE COVERS

A rock solid frame structure, that can withstand the harshest environment, is covered by shock and damage proof ABS covers. The covers avoid damage to the machines high tech interior and stay in a good condition over the years to come. No dents or paint damage from fallen work pieces. Replacement of the covers, if required at all, is easy and economic.

Innovative software functions

The I-TOUCH™ software provides clever multi-function keys for testing, set-up, storing and uploading of test programs, statistic control and more, making tester operation as easy as it can be. Data export, single or batch readings, with a single press on a button, or just fully automatic after measurement can be stored on a USB stick or transfer by cable to a PC to be imported or evaluated in EXCEL.

Further advanced features include extended statistics, shape correction for convex, concave or ball shaped specimens, hardness conversion to Rockwell, Brinell or Tensile strength according to ASTM E140 and ISO 18625 with different material tables.

There is a table top panel with a adjustable viewing angle or an integrated version imbedded in the testers frame. In all cases, the panel is mounted in a solid robust aluminum frame.



OPERATING COMFORT WITH I-TOUCH

INNOVATIVE SOFTWARE FUNCTIONS

1 OUT OF SET LIMITS



2 UNMISTAKEN TURRET POSITION



3 MEASUREMENT OVERVIEW



4 EXPORT FUNCTIONS



OPTIONAL IMAGE

EVALUATION



1

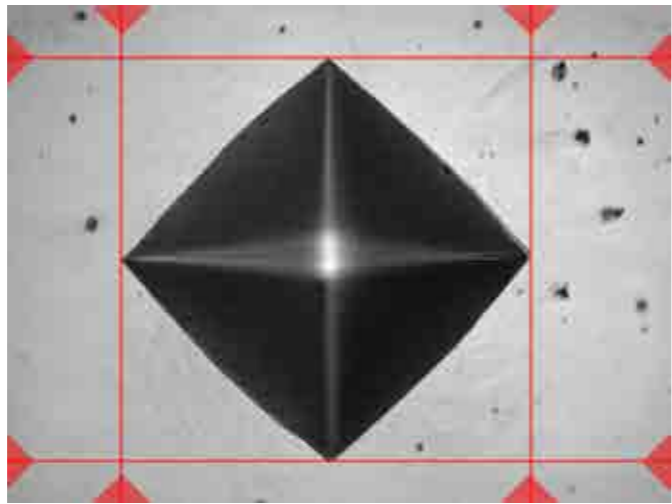

1 AUTOMATIC MEASUREMENT

Manual positioning of filar lines is no longer required. IMPRESSIONS™ refined measurement algorithms detect indents even on very poor or scratched surfaces and measure the relevant indent dimensions according to standards. Stay in control by switching to manual measure mode and have the option of adjusting measurements by touching the screen or using the mouse. Filar lines can be colored to give the best contrast against the specimen's surface. To assure that measurements meet relevant standards on symmetry, enable the automatic indent check. All hardness values can be converted to other scales according to ISO 18265, ISO 50150, ASTM E140.

**Evaluate whatever you want, --
because what gets measured, gets produced...**

2 ILLUMINATION SETTINGS

IMPRESSIONS™ software automatic illumination system adapts to the correct illumination regardless of the sample surface quality, wherever on the sample, independent from material (steel, carbide, coated or ceramic). Contrast, Brightness and program, can be set automatically for each measurement or controlled manually. Sharpness can be stored with the pre-determined test.

Too bright



OK

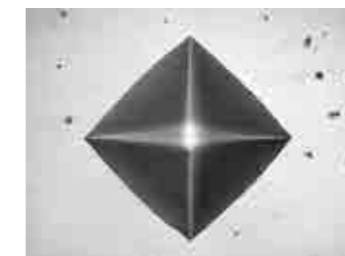

Too dark

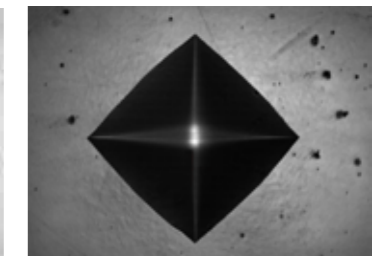

3



Irregular surface

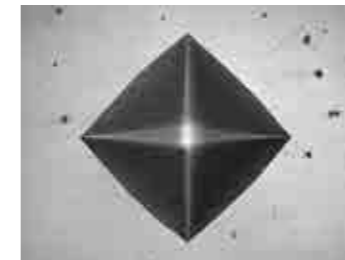

Regular surface

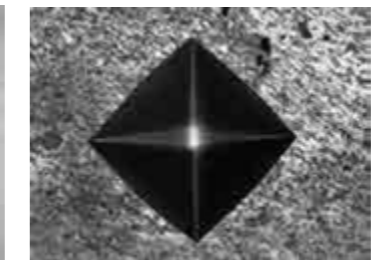

Poor surface

4

3 REFINED IMAGE DETECTION

Complex, refined algorithms ensure reproducible measurements on different materials and even on scratched and damaged surfaces.

OPTIONAL AUTOMATIC INDENT

EVALUATION

Indent evaluation software, also referred to as “tester automation”, often comes with a high level of complexity, both in setup and in operation. Breaking these rules, IMPRESSIONS™ XT (optional) focuses on fast and simple operation, for a less experienced operator.

A very easy to learn, workflow process but with functionality expected by expert users. IMPRESSIONS™ is optimized for evaluating Macro-Vickers, Micro-Vickers, Knoop & Brinell indents according to ISO, ASTM and JIS standards.

SELECT YOUR INDENT EVALUATION PACKAGE:

1 STANDARD (IMP-PACK2)

IMPRESSIONS™ Software for manual and automatic measurement of Vickers / Knoop & Brinell indents, indent zoom function, automatic illumination adjustment.

Package Includes:

*High performance system controller with USB, HDMI, RS-232, WLAN, LAN connectivity. Industrial DVI/HDMI capacitive touchscreen, with wireless keyboard and mouse, 5 Mpx HD industrial CCD camera, cable set.

Software features: Full tester configuration & control system, automatic brightness & contrast setting, automatic measurement of Vickers, Knoop and Brinell indents, manual CHD, SHD, NHD testing procedure, Kic measurement, set up and storing of test programs, set up and storing of tester configuration, limits (go/no go), diagrams, advanced report generator with editor.

NO INSTALLATION, NO ADDITIONAL PC REQUIRED!"

2 ADVANCED (IMP-PACK3 & IMP-PACK4)

As STANDARD package but offers two options :

IMP-3 has one digital micrometre X-axis that transfers the position of the stage to IMPRESSIONS™, whereas IMP-4 has two digital micrometres that transfer the position of the stage to IMPRESSIONS™.



TIME REDUCING SOFTWARE SOLUTIONS...

1 PATTERN EDITOR

The IMPRESSIONS™ pattern editor allows the user to create any number of test patterns with a large number of variable settings. Create test patterns with great precision and freedom. Verify the settings in the preview mode. Drag & drop patterns from one test sample to another sample. Live vision technique over zoom overview camera, no image stitching required.

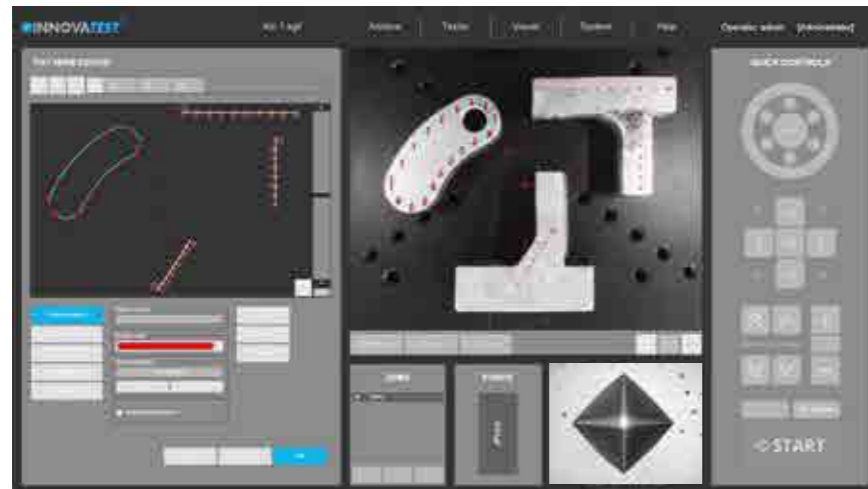

Combine different patterns and even different test forces in one program, and run them fully automatically. All test points can be identified individually or to customer specifications. The label is shown in the test result list and in the test results overview and in the results print out. An important function for sample analyses at the end of a test and in the future for review of previous tests.

2 CHD, SHD, NHD

How do you increase throughput in your lab? Make the most common testing design as easy to set up as possible to perform automatically and still adhere to the applicable standards. CHD/SHD/NHD testing can be started directly from the surface view or from the overview. Additional core points of hardness can be defined separately for NHD measurements.

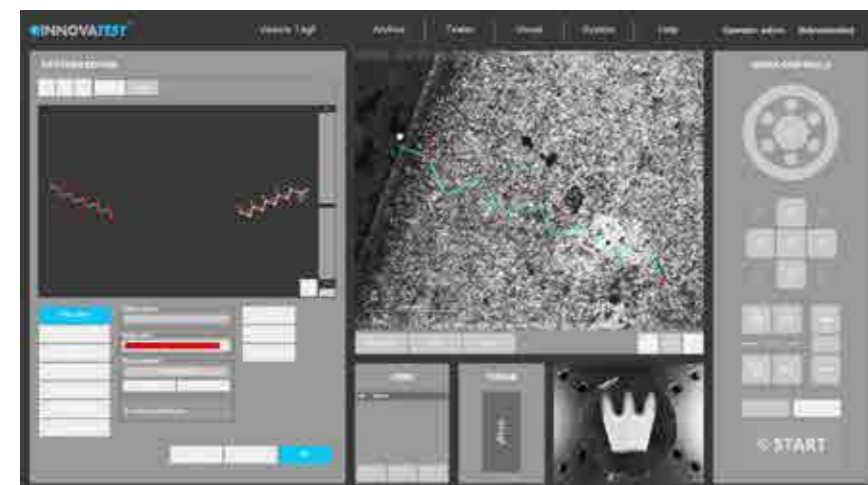

The distances of test points are automatically set to a minimum distance, following the standard, to assure correct testing is conducted. Time saving test mode "complete all indentations - then evaluate" and "auto-stop" to complete test series as soon as the lower hardness limit has been reached. Report Generator is enhanced with reporting features for this application.

3 WELD INSPECTION (ISO 9015)

This especially developed tool enables you to conduct hardness testing on welded parts or segments according to ISO standard. Setting up the pattern according to the requirements becomes "easy-to-do", due to pre-set test points in the different zones of the weld and automatic correlation between test points. The system will run a fully automatic test procedure and display and record the results accordingly. The Report Generator is enhanced with reporting features for this application.

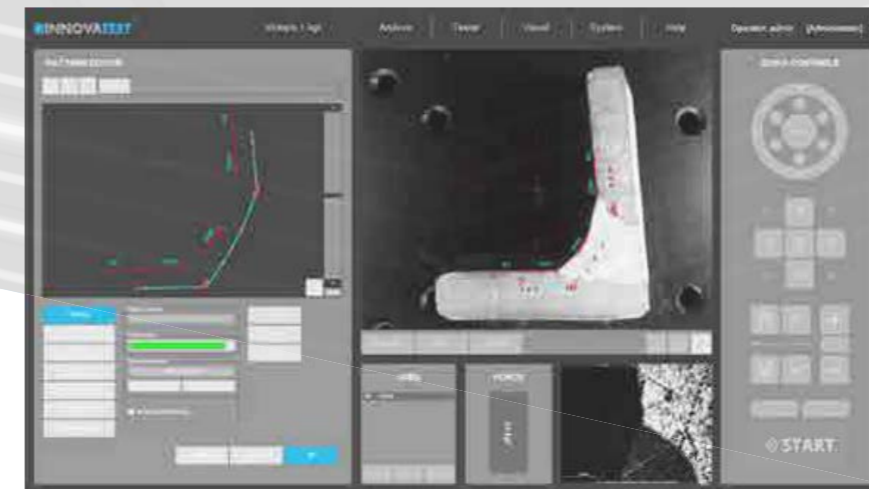

4 HARDNESS OF SCREW THREAD DECARBONIZED ZONE (ISO898-1)

A specialized software tool of IMPRESSIONS™ allows you to set up and conduct fully automatic testing as per ISO898-1 for screw thread measurement of (de)-carbonized part.



The Report Generator is enhanced with reporting features for this application.

5 EDGE DETECTION

Technology that automatically or at a mouse click recognizes the edge of your sample. This helps to determine and fix the desired starting position for CHD or other pattern testing jobs.

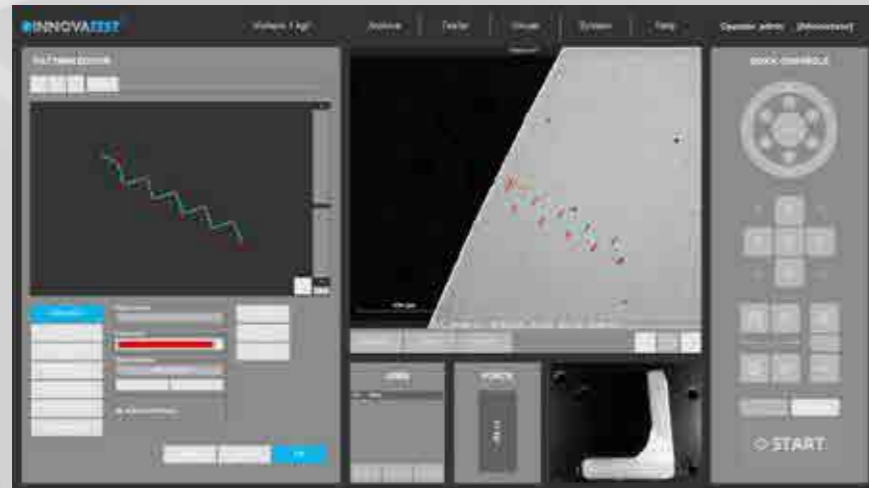

7 2D HARDNESS CHART

The application „Plane hardness chart“, is also referred to as Color Mapping happens to be the perfect tool for securing the detail of the effective hardness distribution over the total sample cross section of heat treated samples. An important feature in material exploration, weld testing or in damage analysis.

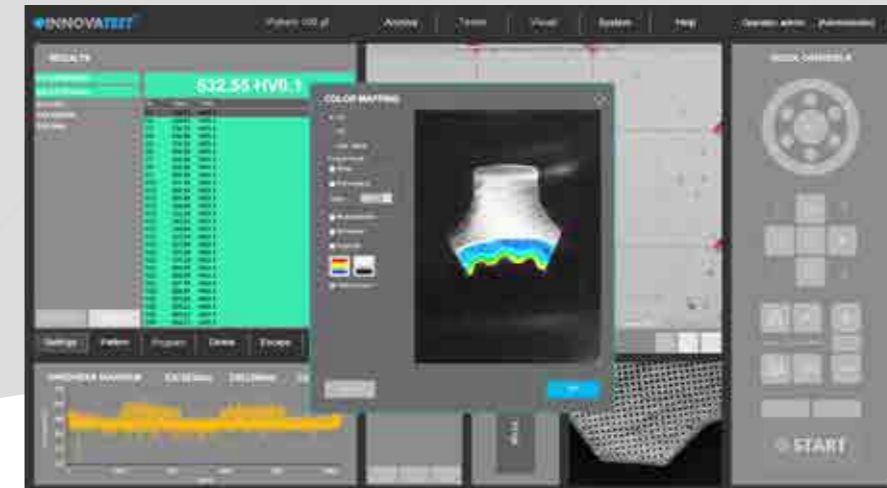

6 AUTOMATIC CONTOUR SCANNING

This application scans the entire outline (or partial) area of a sample. The function can be used with an objective by using the overview zoom camera for high speed scanning. The system scans the entire outline defined and stores all relevant data in the test program.

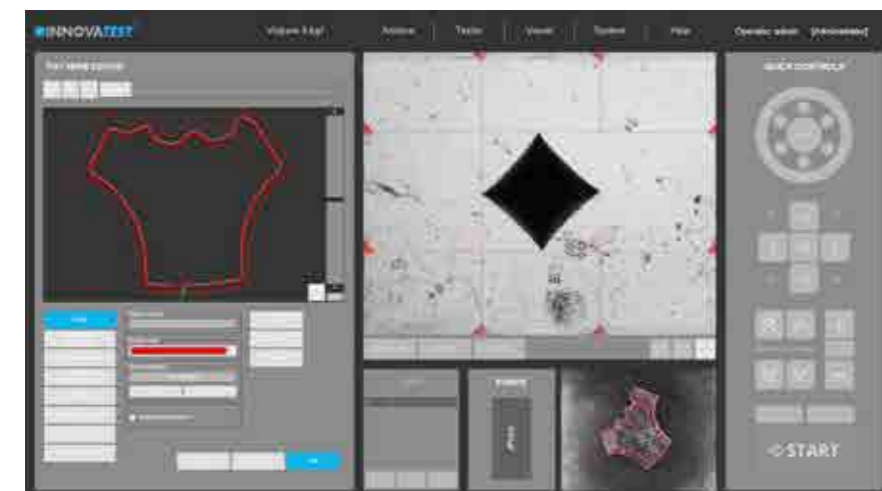

8 3D HARDNESS CHART

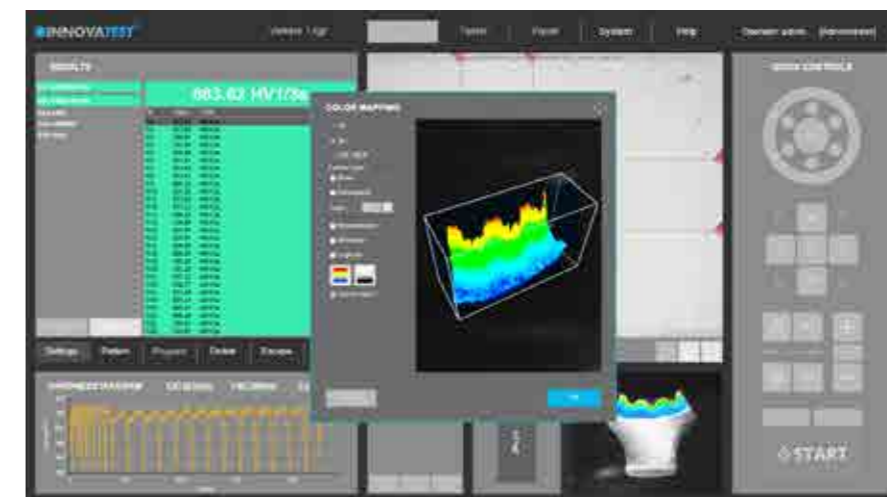

In addition to 2D graphic diagrams, the system can also automatically generate 3D diagrams. 2D and 3D hardness charts are included in one application.

Subsequently, a limitless number of test points can be inserted into the scanned image, or be set at selected distances (offset), relative to the edge. This advanced feature enables the hardness testing procedure to be performed c. An excellent featured combined with 2D or 3D hardness mapping, also known as “plane hardness chart”.

9 Kic CRACK MEASUREMENT

For those requiring more in depth knowledge on materials behavior, wishing to study material fracture and fatigue, crack growth can be predicted and measured by using the Kic application.

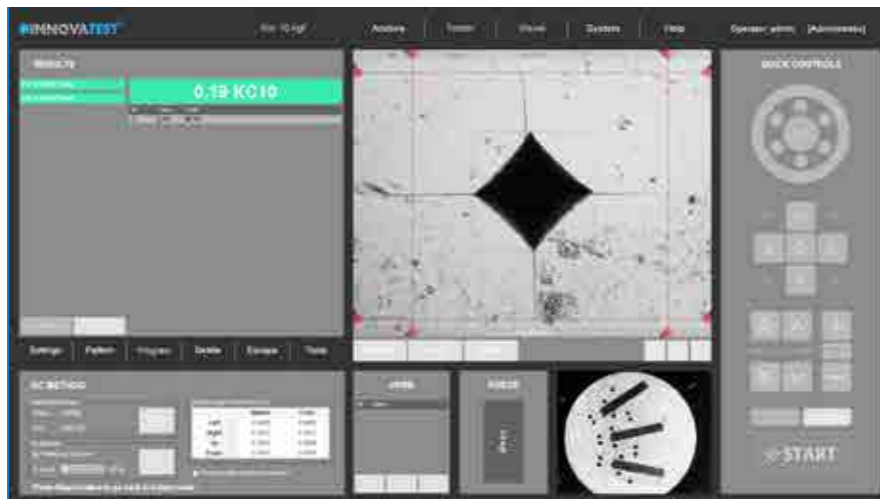

The software supports Kic crack detection under load with customized Kic result reporting. By way of one or both methods, Palmqvist or Median / Radial, fracture toughness is now a repeatable and reproducible test across multiple operators.

10 SNAPSHOT FUNCTION



This handy function in IMPRESSIONS™ allows you to make screen captures of the viewing area by way of objective view and/or Overview camera. It gives the opportunity to store such images with comments or to paste them into the report generator for further processing.

11 USER DEFINED PROGRAMS

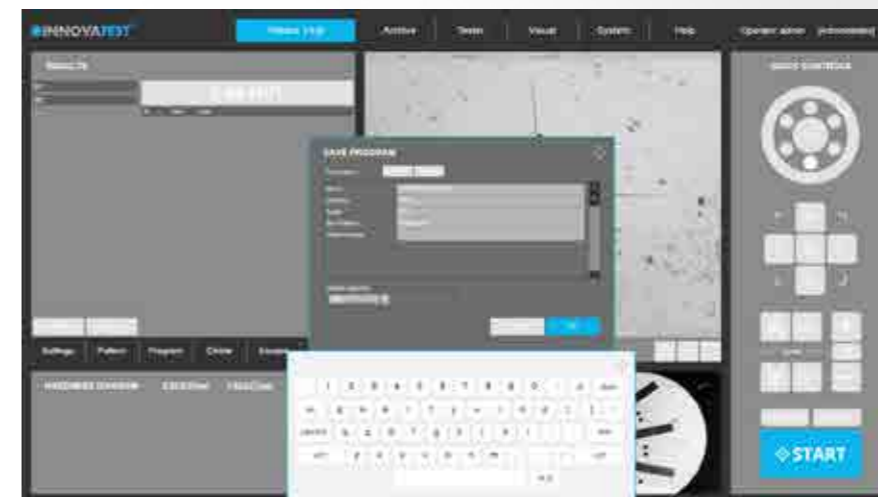

For repeating jobs, IMPRESSIONS™ utilizes the option of setting up and storing custom test programs. For each task, a "job" can be created. All application specific parameters, such as hardness scale, force, dwell-time, pattern, conversion and the report template are stored in the same program.

12 REPORT GENERATOR



Imagine having a report created for you that includes: Your company name, address, contact information, labeled results related to patterns or sequential, pictures of your optical measurements, stitched images, notes section for each result or pictures, rendition of the pattern performed, overview picture of your pattern on your sample, full statistics, summary of your results, go no-go results, Pass or fail...

All this information or having the ability to only have what you need reported, we call this our Report Configurator. You decide how much or how little you report by PDF or laser printer. We even keep it simple by choosing export to CSV file, to a thumb drive or network file location. Data management at its best!



LIMITLESS POSSIBILITIES

The FALCON 300G2 is routinely used for testing materials, components or parts in the aerospace and automotive industry, laboratories for sample evaluation or to conduct advanced testing tasks. The shock and damage proof covers protect are high-tech interior of this unique Micro-Macro Vickers machine.

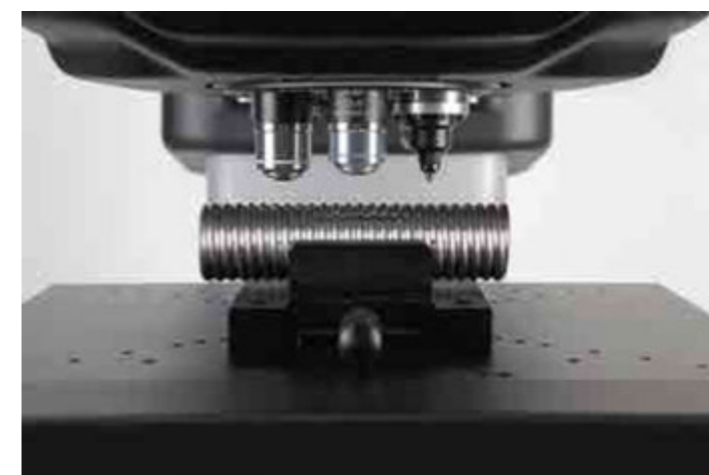
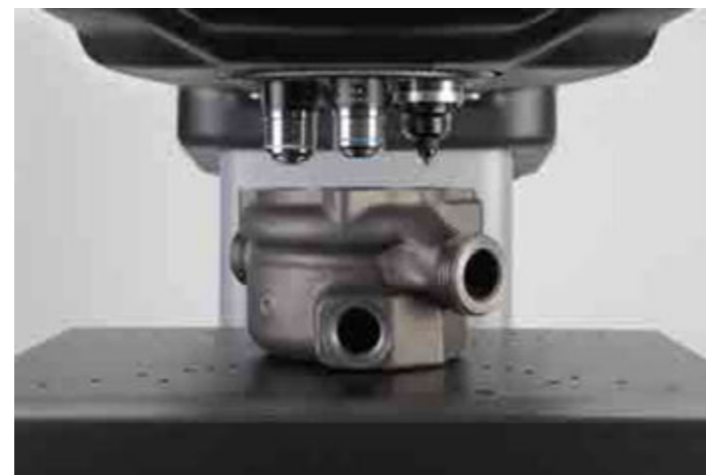

FALCON 300G2

CONFIGURE NOW :



STEP 1: Select machine



STEP 2: Force range

5gf -2kgf

STEP 3: Indenters

1 Indenters

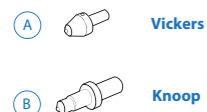

STEP 4: Optical

2 Eyepieces



3 Objectives

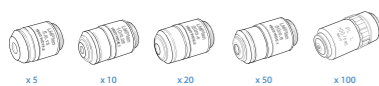

STEP 5: Stages/Anvils

4 Stages

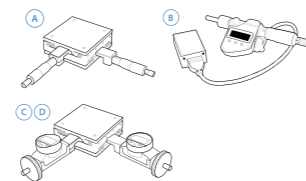

5 Anvils

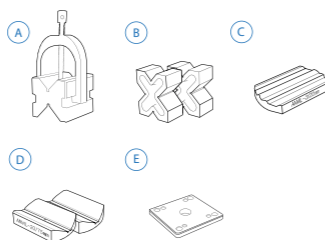

STEP 6: Sample holders

6 Sample holders

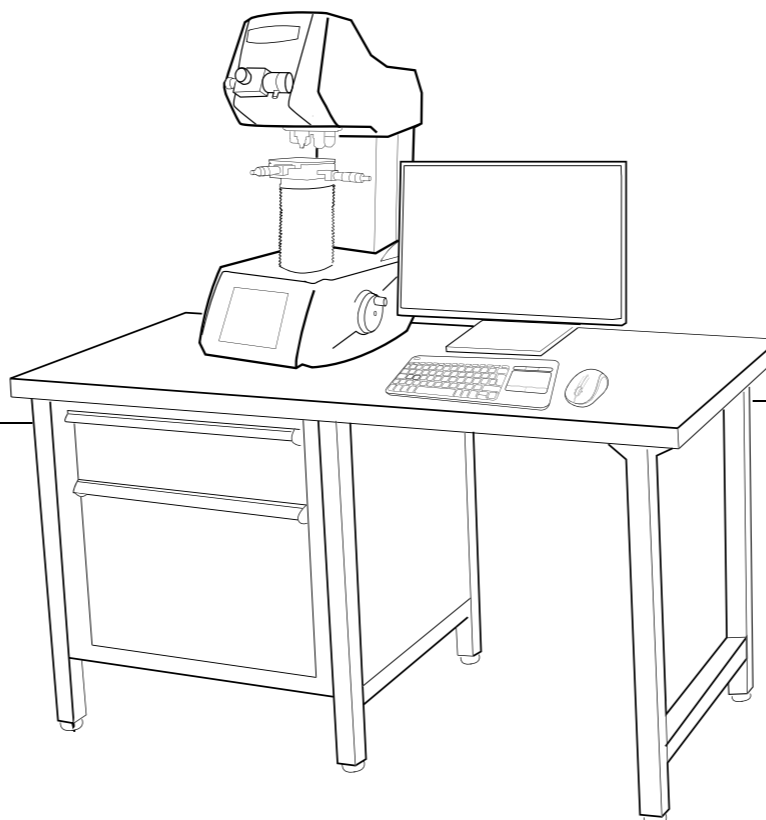
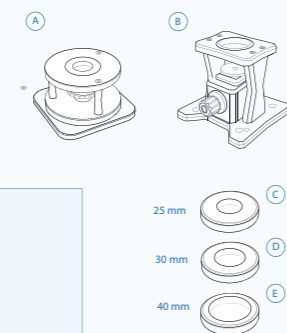

STEP 7: Fixtures & Vices

8 Fixtures & Vices

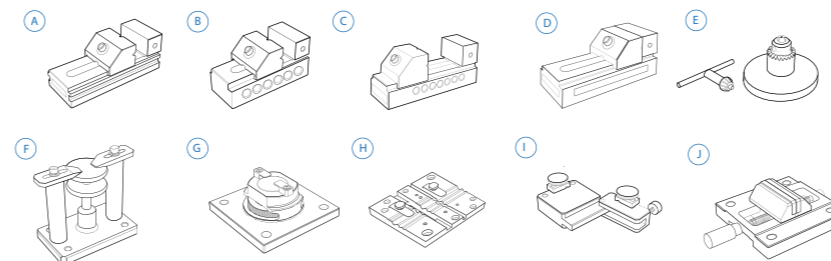

STEP 8: Software

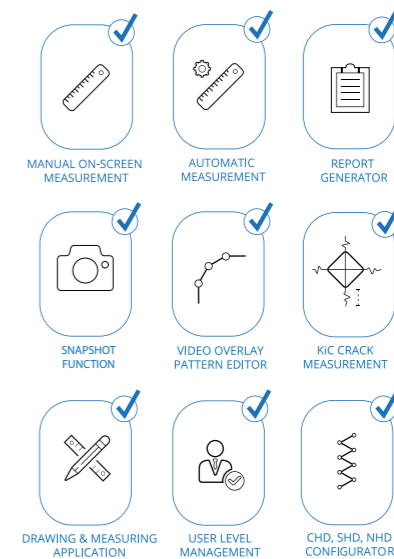

✓ = Standard included with IMP-PACK

ORDER DETAILS

FALCON 300G2



FALCON 300G2 Micro hardness tester, 5gf - 2kgf	FALCON 300G2	
Indenter actuator post (2nd indenter position) factory installed	SA-70-0003	
Plug & Play prepared, calibration, sea & airworthy packing in "non coniferous wood" material	P&PSEAPACK10	

ACCESSORIES

STEP 3	Indenters					
1	Vickers	A	Micro Vickers Indenter Ø3mm ISO/ASTM certified	UPI/8105		
	Knoop	B	Micro Knoop Indenter Ø3mm ISO/ASTM certified	UPI/8205		
STEP 4	Optical					
2	Eyepieces	A	Electronic digital eyepiece with 15x magnification	AS-EYEPIECE/03		
		B	Analogue eyepiece with 15x magnification	AS-EYEPIECE/04		
3	Objectives		5x Long Working Distance (LWD) objective	BM-05-0001		
			10x Long Working Distance (LWD) objective	BM-05-0002	STANDARD	
			20x Long Working Distance (LWD) objective	BM-05-0003		
			50x Long Working Distance (LWD) objective	BM-05-0004	STANDARD	
			100x Long Working Distance (LWD) objective	BM-05-0005		
STEP 5	Stages/Anvils					
4	Stages	A	Manual X-Y stage with analogue metric micrometers, 100x100mm Displacement: 25x25mm, scale 0.01mm, max load 60kg	UN-XYSTAGE/115	STANDARD	
				Fixing bush with flat mounting surface	CM-08-0003	STANDARD
		B	Digital micrometer, for manual X-Y stage, Displacement: 25mm, resolution 0.001mm	IMP-DIGMIC		
5	Anvils	A	Anvils Flat anvil 60mm	AS3000-19-04		
			B	Flat anvil 80mm	UN-TESTTABLE/002	
			C	V block with bracket 40x40x50mm (LxBxH)	UN-VBLOCK404050	
			D	Steel, cross type, (X) V-block 60x120x100mm 8-90mm pair	UN-CROSSBLOCK01	
			E	V-anvil ø40mm 6-60mm	UN-ANVIL/005	
			F	V-anvil ø63mm 10-100mm	UN-ANVIL/006	
			G	Cylindrical V anvil 6-80mm	UN-CVANVIL680	
			H	Cylindrical V anvil 50-200mm	UN-CVANVIL50200	
				Test table 100x100mm, V grove 20mm wide, 10mm deep	UN-TESTTABLE/040	
		I	Small V-Anvil 3-20mm requires base plate (Requires Manual/Autom. X-Y stage)	UN-ANVILSV/105		

		J	Large V-Anvil 20-75mm requires base plate (Requires Manual/Autom. X-Y stage)	UN-ANVILLV/106		
		K	Base plate for V-anvils un-anvilsv/105 & 106	UN-VANVILBASEPL		
STEP 6	Sample holders					
6	Sample holders	A	1 position sample holder, for 1 embedded sample, diameter 50mm or 2"	UN-ESH1		
			B	1 position sample holder, for 1 embedded sample, diameter 50mm or 2" with front operation elevator knob	BM-08-0052	
			C	1 insert reduction ring 25mm	UN-ESHI25	
			D	1 insert reduction ring 30mm	UN-ESHI30	
			E	1 insert reduction ring 40mm	UN-ESHI40	
				1 insert reduction ring 1"	UN-ESHI1	
				1 insert reduction ring 1 1/4"	UN-ESHI125	
			1 insert reduction ring 1,5"	UN-ESHI15		
STEP 7	Fixtures & vices					
7	Fixtures & vices	A	Polished precision vice with lock down system, jaw width 25mm, opens 20mm	UN-VICE/210		
			B	Polished precision vice with lock down system, jaw width 36mm, opens 42mm	UN-VICE/215	
			C	Polished precision vice with lock down system, jaw width 48mm, opens 75mm	UN-VICE/220	
			D	Polished precision vice with lock down system, jaw width 75mm, opens 100mm	UN-VICE/230	
			E	Axle chuck 500 series for cylinder parts, dia. 0.4mm to 5mm	UN-AXLECHUCK	
			F	Universal Clamp & Leveling Device	UN-CLAMP/105	
			G	Thin metal clamp	UN-CLAMP/115	
			H	V groove clamp for small round parts dia.0.8-5mm	UN-VGROOVE-CLAMP	
			I	Wire Testing Fixture for specimen dia. 0.8-3.5mm	UN-WIRE/105	
			J	Small parts vice jaw width 55mm, open 50mm, self centering	UN-VICE/115	
STEP 8	Software					
	Additional software		Manual on-screen measurement	UN-MANM	* IMP-PACK 2,3,4	
			Automatic measurement	UN-AUTOM	* IMP-PACK 2,3,4	
			Report configurator	UN-REPORTA	* IMP-PACK 2,3,4	
			Snapshot function	UN-SNAPSH	* IMP-PACK 2,3,4	
			Advanced 3 axis coordinate & free style indent pattern configurator, + CHD, SHD, NHD and edge detection, (supports manual & digital micrometer stages only)	UN-TESTPAT02	* IMP-PACK 2,3,4	
			Kic crack detection under load. Palmqvist & Median / Radial fracture toughness	UN-CRKPAP	* IMP-PACK 2,3,4	
			Drawing and measuring (distance & angles) application	UN-DRMEAS	* IMP-PACK 2,3,4	

		Automatic edge detection	UN-EDGEDTC	* IMP-PACK 2,3,4
		User level management	UN-LEVMAN	* IMP-PACK 2,3,4
		CHD, SHD, NHD configurator & graphic interface for analogue and digital micro meter stage only (not including full pattern editor)	UN-MCHD	* IMP-PACK 2,3,4
8	Machine stands	A Cabinet test table with drawer for hardness testers 71x75x80cm	UN-STAND/960	
		B Cabinet test table with drawer for hardness testers 150x75x80cm	UN-STAND/965	
		Seaworthy packing box for 950/960	PACK/100	
		Seaworthy packing box for 965	PACK/200	
9	Vibration isolation stage	Passive vibration isolation stage, broad spectrum	UN-AVS-150	
	Printer	Laser Printer	UN-PRINT	
	Machine cover	Machine cover 350x550x770mm	UN-COVER1	
	ISO 17025 UKAS	UKAS EN ISO 17025 Direct/Indirect calibration report	CCERTFEE/UKAS	
	ISO 17025 UKAS ISO / ASTM Calibration	VICKERS direct and indirect calibration & certification, traceable, in compliance with ISO & ASTM, NADCAP. Flat fee for selected common scales, per scale.	CCERTUKAS/1V	
	ISO 17025 UKAS ISO / ASTM Calibration	KNOOP direct and indirect calibration & certification, traceable, in compliance with ISO & ASTM, NADCAP. Flat fee for selected common scales, per scale.	CCERTUKAS/1K	

* Standard in combination with mentioned IMP-PACK.

SOFTWARE PACKS

GUI: Full tester & configuration control, 3 simultaneous conversions to other hardness scales, limit settings, color indication for measuring results, results list with highlighted in and out of limit values, graphics engine to display turret positions and indenter positions, test force progress bar.	STANDARD	
Full tester configuration & control system, automatic brightness & contrast setting, automatic measurement of Vickers, Knoop and Brinell indents, manual CHD, SHD, NHD testing procedure, Kic measurement, set up and storing of test programs, set up and storing of tester configuration, limits (go/no go), diagrams, advanced report generator with editor. NO INSTALLATION, NO ADDITIONAL PC REQUIRED!	SA-70-0006	
Full tester configuration & control system, automatic brightness & contrast setting, automatic measurement of Vickers, Knoop and Brinell indents, manual CHD, SHD, NHD testing procedure, Kic measurement, set up and storing of test programs, set up and storing of tester configuration, limits (go/no go), diagrams, advanced report generator with editor. NO INSTALLATION, NO ADDITIONAL PC REQUIRED!	SA-70-0007	
Full tester configuration & control system, automatic brightness & contrast setting, automatic measurement of Vickers, Knoop and Brinell indents, manual CHD, SHD, NHD testing procedure, Kic measurement, set up and storing of test programs, set up and storing of tester configuration, limits (go/no go), diagrams, advanced report generator with editor. NO INSTALLATION, NO ADDITIONAL PC REQUIRED!	SA-70-0008	

ACCESSORIES

EYEPIECES



AS-EYEPIECE/03



AS-EYEPIECE/04

OBJECTIVES



5x Long Working Distance objective



50x Long Working Distance objective



10x Long Working Distance objective



100x Long Working Distance objective



20x Long Working Distance objective

INDENTERS



Micro Vickers Indenter Ø3mm



Micro Knoop Indenter Ø3mm

STAGE



UN-XYSTAGE/115



IMP-DIGMIC

ANVILS



AS3000-19-04



UN-TESTTABLE/002



UN-VBLOCK404050



UN-CROSSBLOCK01



UN-ANVIL/005



UN-ANVIL/006



UN-CVANVIL680
UN-CVANVIL50200



UN-ANVILSV/105



UN-ANVILSV/106



UN-VANVILBASEPL

FIXTURES AND VICES



UN-VICE/210



UN-VICE/215



UN-VICE/220



UN-VICE/230



UN-AXLECHUCK



UN-CLAMP/105



UN-CLAMP/115



UN-VGROOVE-CLAMP



UN-WIRE/105



UN-VICE115

SAMPLE HOLDERS



UN-ESH1



BM-08-0052



UN-ESH25



UN-ESH30



UN-ESH40



UN-ESH1



UN-ESH125



UN-ESH15

MACHINE STANDS



UN-STAND/960



UN-STAND/965

VIBRATION ISOLATION STAGE



UN-AVS-150

SPECIFICATIONS

HARDNESS SCALES

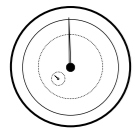
	VICKERS ISO 6507 ASTM E384, E92 JIS B 7725	HV0.005 HV0.006 HV0.007 HV0.008 HV0.009 HV0.010 HV0.015 HV0.020 HV0.025 HV0.050 HV0.1 HV0.2 HV0.3 HV0.5 HV1 HV2
	Kic Fracture toughness	All available Vickers forces & scales
	KNOOP ISO 4545 ASTM E92 JIS Z 2251	HK0.005 HK0.006 HK0.007 HK0.008 HK0.009 HK0.010 HK0.015 HK0.020 HK0.025 HK0.050 HK0.1 HK0.2 HK0.3 HK0.5 HK1 HK2
CONVERSIONS	Conversion to other hardness scales according to ASTM E140, ISO 18265, GB/T 1172	

TEST FORCE

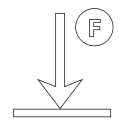
	Force application	load cell, closed loop, force feedback system
	Force range	5gf – 2kgf
	Test force tolerance	< 0.5% for all test forces
	Dwell time settings	Default 10 seconds, user defined.
	Motorized turret	Ultra-fast, 6 position turret, 2 indenter positions, 4 objective positions

TURRET

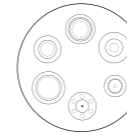
	Objectives	Long working distance 5x, 10x, 20x, 50x, 100x
	Indenters	Certified indenters (ISO/ASTM) available at choice
	Eyepiece	Analogue eyepiece with 15x magnification Electronic digital eyepiece with 15x magnification (optional)
	Camera	5 Mpx optical zoom system (optional)

SYSTEM

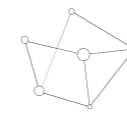
	Electronic system	High performance embedded electronics system running I-TOUCH™ firmware
	Screen(s)	6.5" display, 15" LCD screen (IMP-PACK)
	Display resolution	0.1 HV, HK, 0.5 HB
	Statistics	Total test, max, min, average, range, standard deviation, All in real time after each test
	Hardness conversion	Rockwell, Rockwell Superficial, Vickers, Brinell, Knoop, Leeb & Tensile
	Software	I-TOUCH™ firmware, workflow system & tester control IMPRESSIONS™ V2, workflow system & tester control (IMP-PACK)
	Data output	USB
	Connectivity	USB-2
	Printer	A4, A3 full color laser printer (optional)

GENERAL

	Machine dimension	525mm x 323mm x 688mm
	Workpiece accommodation	150mm (H) x 170mm (D)
	Machine weight	75 kg
	Power supply	100VAC to 240VAC, 50/60Hz, single phase
	Operating temperature	10°C to 35°C
	Noise	< 70 db(A)
	Power consumption	75W
	Humidity	10% to 90%, non-condensing

TECHNICAL DRAWINGS

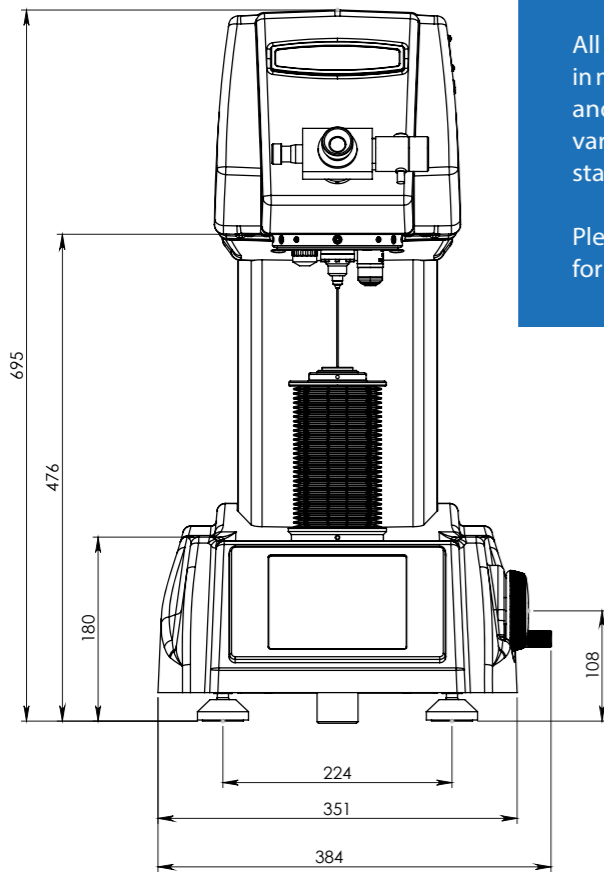

All dimensions in these drawings are in mm, approximate. Working heights and or workpiece accommodation varies depending on the stages and stage accessories used.

Please contact our sales department for more details.

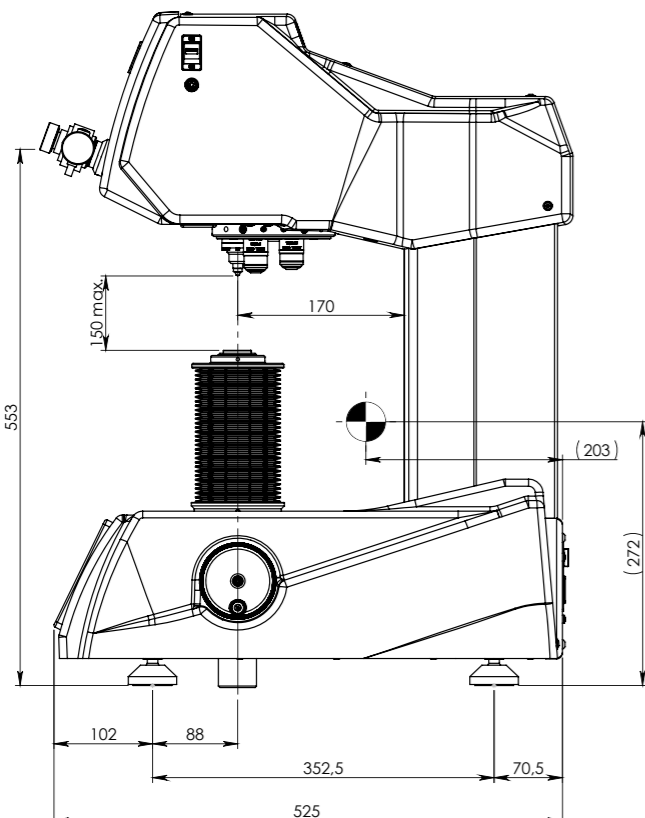

Changes in products and/or product specifications can emerge due to new technologies and continuous development.

We reserve the right to change or modify specifications of the products without prior notice. We recommend you to contact our sales office for up-to-date information.

Brochure B23F300G2/04/EN

OTHER MODELS IN THE FALCON RANGE



FALCON 400G2

1gf - 62.5kgf

Load Cell, Closed loop
Micro/Macro Vickers, Knoop & Brinell Hardness testers
With fine adjustable Z-axis side handwheel
See brochure B22F400G2/XX



FALCON 450G2

200gf - 62.5kgf

Load Cell, Closed loop
Macro/Micro Vickers, Knoop & Brinell Hardness tester
With Z-axis handwheel
See brochure B18F450/XX



FALCON 500G2

0.1gf - 62.5kgf

Multi Load Cell, Closed loop
Fully automatic, free to configure Micro/Macro Vickers, Knoop & Brinell Hardness testers. With ball bearing motorized Z-axis
See brochure B18F500/XX



FALCON 600G2

0.1gf - 62.5kgf

Multi Load Cell, closed loop
Fully automatic, free to configure Micro/Macro Vickers, Knoop & Brinell Hardness testers. With ball screw motorized Z-axis
See brochure B22F600G2/XX



FALCON 800G2

0.1gf - 62.5kgf

Multi Load Cell, closed loop
Fully automatic, 8 position turret, laser positioning.
Micro/Macro Vickers, Knoop & Brinell Hardness testers.
Descending test head, fixed work piece position
See brochure B22F5000G2/XX



FALCON 5000G2

10gf - 62.5 | 250 | 750kgf

Multi Load Cell, closed loop
Fully automatic, 8 position turret, laser positioning.
Micro/Macro Vickers, Knoop & Brinell Hardness testers.
Descending test head, fixed work piece position
See brochure B22F5000G2/XX

www.innovatest-europe.com

EUROPE

INNOVATEST Deutschland GmbH.
Sales & Service
Phone: +49 245 670 59 500
info@innovatest-deutschland.com
www.innovatest-deutschland.com

INNOVATEST France SARL
Sales & Service
Phone: +33 1 848 88038
commercial@innovatest-france.com
www.innovatest-france.com

INNOVATEST UK Ltd.
Sales & Service
Phone: +44 (0) 121 824 4775
info@innovatest-uk.com
www.innovatest-uk.com

INNOVATEST Polska sp. z o.o
Sales & Service
Phone: +48 697 099 826
info@innovatest-polska.pl
www.innovatest-poland.com

MIDDLE EAST

INNOVATEST Middle East LLC
Sales & Service
Phone: +971- 4- 880 0875
info@innovatest-mideast.com
www.innovatest-mideast.com

NORTH-AMERICA

INNOVATEST USA Inc.
Sales & Service
Phone: +1 267 317 4300
info@innovatest-usa.com
www.innovatest-usa.com

ASIA

INNOVATEST Shanghai Co., Ltd.
Sales & Service
Phone: +86 21 60906200
Fax: +86 21 60912595
info@innovatest-shanghai.com
www.innovatest-shanghai.com

INNOVATEST Japan K.K.
Sales & Service
Phone: +81 3 6667 0554
Fax: +81 3 6667 0556
info@innovatest-japan.com
www.innovatest-japan.com

INNOVATEST South East Asia
Sales & Service
Phone: +65 6451 1123
Fax: +65 6452 1011
info@innovatest-singapore.com
www.innovatest-singapore.com

Distributor :

CORPORATE HEAD OFFICE

INNOVATEST Europe BV
Manufacturing, Distribution & Service
Borgharenweg 140
6222 AA MAASTRICHT
The Netherlands

Phone: +31 43 3520060
Fax: +31 43 3631168
info@innovatest-europe.com
www.innovatest-europe.com